

# Starrett®

## Tools & Rules

for Precision Measuring



“Man is a tool-using animal. Weak in himself and of small stature, he stands on a basis of some half square foot, has to straddleout his legs lest the very winds supplant him. Nevertheless, he can use tools, devise tools; with these the granite mountain melts into light dust before him; seas are his smooth highway, wind and fire his unwearying steeds. Nowhere do you find him without tools. Without tools he is nothing, with tools he is all.”

*Thomas Carlyle (1795-1881)*

**The L. S. Starrett Company**

**121 Crescent Street, Athol, MA 01331**

**978-249-3551 • [starrett.com](http://starrett.com)**

© 2009

## Introduction

This booklet is primarily a resource for students in vocational schools and industrial training class apprentices. We hope it will assist instructors, students and apprentices to better understand their precision measuring tools.

Tools & Rules does not attempt to describe all of the precision measuring tools available. Additional product and reference information is available in the Starrett catalog and on the Starrett website (starrett.com). Your Starrett industrial distributor can also be an invaluable source of information about tools and related products that they supply.

For over 125 years of precision tool-making, the L. S. Starrett Company has encouraged higher standards of workmanship by helping vocational students and apprentices understand tools and how to use them effectively.

Starrett offers moderately priced apprentice tool sets that provide dependable, high quality tools to begin their careers. We also offer a variety of reference materials at no charge. To see the available selection and order, go to the Starrett website, select the "Literature" button and order what you need. Industrial arts and vocational instructors, industrial training supervisors and private sector educators are encouraged to utilize these valuable training aids in their teaching programs.

## Contents

<b>Introduction</b> .....	<b>1</b>
<b>Linear Measurements</b> .....	<b>7</b>
<b>Slide Calipers</b> .....	<b>10</b>
<b>How to Transfer Measurements</b> .....	<b>13</b>
<b>Depth Gages</b> .....	<b>14</b>
<b>Combination Sets</b> .....	<b>15</b>
<b>Micrometers</b> .....	<b>17</b>
<b>Vernier Tools</b> .....	<b>28</b>
<b>Depth Gages</b> .....	<b>39</b>
<b>Work Location</b> .....	<b>41</b>
<b>Measuring Lathe Work</b> .....	<b>42</b>
<b>Ground Flat Stock</b> .....	<b>43</b>
<b>Measurements of Length and Diameter</b> . . .	<b>44</b>
<b>Measuring Screw Threads</b> .....	<b>45</b>
<b>Measuring Angles</b> .....	<b>47</b>
<b>Dial Indicators</b> .....	<b>49</b>
<b>Granite Surface Plates</b> .....	<b>57</b>
<b>Data Collection</b> .....	<b>58</b>
<b>Gage Blocks</b> .....	<b>60</b>
<b>Optical Measuring Projectors</b> .....	<b>63</b>
<b>Vision Systems</b> .....	<b>64</b>
<b>Facts About Fits</b> .....	<b>65</b>
<b>Limits</b> .....	<b>65</b>
<b>Reference Tables</b> .....	<b>68</b>
<b>Educational Material</b> .....	<b>76</b>

## The Tools and Rules for Precision Measuring

Mass production demands precision measuring. The parts in any product must be interchangeable. Uniformity is assured and controlled through every operation by accurate measuring equipment. From blueprint to finished assembly, precision measuring ensures repeatability. For precision measuring, the skilled machinists, toolmakers and inspectors must have accurate tools, produced from quality materials, carefully manufactured and rigidly inspected, to ensure lasting dependability. Accurate tools in the hands of skilled mechanics result in work approaching perfection.

### Earliest Measuring Tools

Precision has not always been associated with measurement. At the dawn of civilization, man began to use parts of the body to estimate dimensions and around 6000 B.C., from such measurements, there evolved the first standards of measurement: the inch, hand, span, foot, cubit, yard and fathom.

The tools of the past did not demand great accuracy. Most products were custom made by hand and a fraction of an inch one way or the other made little difference to satisfactory operation.

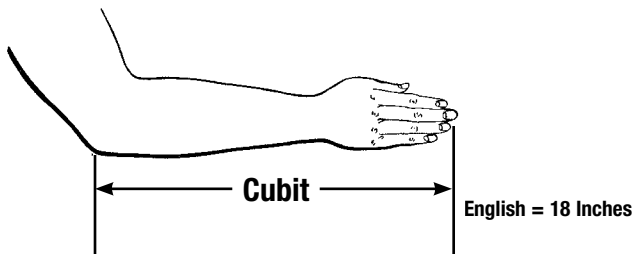
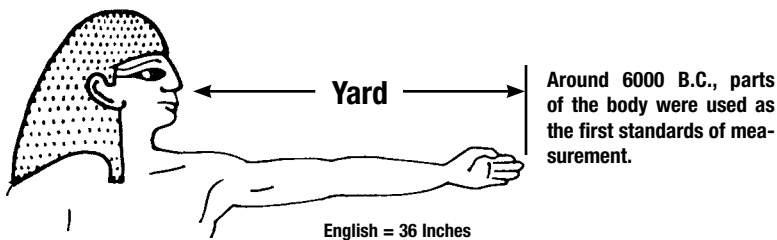

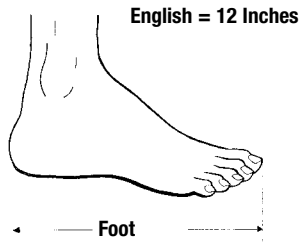
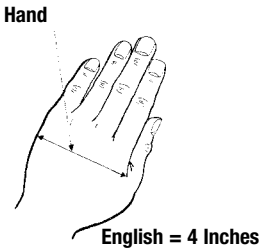
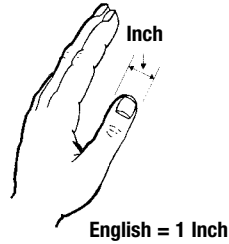
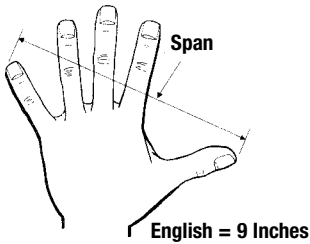

It was Eli Whitney who first conceived the basic idea of mass production through interchangeable parts. It was only through improved methods of measurement and mechanically powered machines that would mass production become possible. In 1800 he successfully applied his theories to the manufacture of muskets for the U.S. Government and is remembered today as the father of mass production through duplicate parts.

Beginning with Eli Whitney's concept, the 19th century saw a tremendous growth in mass production of all types of goods. Another factor was the greater use of mechanically powered machine tools instead of hand tools, along with better measuring devices. Machines and measuring tools approaching the accuracy of modern standards were not developed until after the Civil War.

In 1848 in China Maine, a boy of twelve developed an interest in tools which led him in later years to establish a great company which earned the title, "World's Greatest Toolmakers." That boy's name was Laroy Starrett. His love of tools and a flair for invention sparked a long career that brought Eli Whitney's concept of mass production to precision tools.

Laroy Starrett had "invention on the brain" and as a young man on the farm he spent much of his time in winter and on stormy days working with tools and developing ideas. His first invention was a meat chopping machine which he began to manufacture and sell throughout the country. In 1868 he moved to Athol MA, and resumed operations in a small shop.

## Modern Measuring Tools



Laroy Starrett's main interest however, was in the development of precision measuring tools. The Combination Square was the first in a long line of tools he invented. From 1877 throughout the rest of his life, he devoted all of his energy and Yankee ingenuity to creating new and improved tools. Among these were spring tempered and flexible steel rules, steel tapes, calipers and dividers, the micrometer caliper, Vernier calipers, height gages and many other tools and metal cutting saw blades. This was Laroy Starrett's contribution to the present modern science of precision measuring and to the growth of industry as we know it today.

**The first Combination Square was invented in 1877 by Laroy Starrett, founder of the L.S. Starrett Company .**

Nearly all measurements common in shop practice involve measurements of length. Linear measurements are so numerous and of such importance that a multitude of measuring tools are available for the purpose of obtaining them.

---

## The Yard and The Meter

Two units of measurement are common in the United States: the British yard and the meter, as defined by the Weights and Measures Act of 1878. The yard, once loosely defined as the distance from thumb-tip to the end of the nose of English King Henry I, is most familiar in its subdivisions of feet, inches and fractions of an inch. These crude but practical measurements evolved into a more precisely defined length as the distance between lines inscribed on two gold plugs in a bronze bar when taken at a specified room temperature. A prototype of the yard is kept in the National Institute of Standards and Technology in Washington D.C. Today this standard is not precise enough and the evolution of practical measurements is now defined as the international inch in terms of light waves.

The meter is the basis of the metric system accepted as the standard system of measurement in many countries. The meter was originally set up to be one ten-millionth part of a meridian running north to south through Paris from the North Pole to the Equator. In a short time this proved false, so the meter was simply set up to an arbitrary length and today, like the international inch, it too is defined in terms of light waves. The meter is subdivided into centimeters, millimeters, and parts of a millimeter. Most shops handling instruments and scientific work as well as producing parts for export are equipped with measuring tools calibrated by the metric system.

## ***The International Meter and Inch***

Over the years the international meter has been defined in different ways. Currently the meter equals the distance light travels in a vacuum during 30.663318 cycles of a Cesium atom. This of course cannot be used for regular measurement, so the physical relationship is translated by the National Institute of Standards and Technology using lasers and atomic clocks and transferred to gage blocks.

Gage blocks are the tools that bring this technology to the shop floor where different sizes of blocks may be combined to give any required dimension. When translating from inch to metric or reverse,  $1' = 25.4\text{mm}$  exactly.



---

## ***Know Your Limits***

Striving for accuracy beyond prescribed limits can be just as inefficient and wasteful as gross inaccuracy. Not even pride of workmanship can justify craftsmen slowly and painstakingly producing parts to an accuracy of one ten-thousandth while others turn out matching components that merely meet the specified tolerance of plus or minus several thousandths. It is the purpose of this booklet to review the means and methods of achieving uniform accuracy according to the standards commonly accepted in industry today.

**Gage blocks are primary standards with accuracies to a few millionths of an inch**

---

## ***Sight and Touch***

Developments in precision measuring have made modern tools more accurate and far easier to read. Many newer tools have dial indicators, electronics, digital readout, etc. However, to develop habits of consistent accuracy in measurement, remember that we still are dependent upon the sense of sight and sense of touch.



The sense of touch is particularly important when using contact measuring tools. A skilled machinist with a highly developed sense of “feel” can readily detect a difference in contact made by changes in a dimension as small as 0.00025" (.006mm). While the acuteness of the sense of touch varies with individuals, it can be developed with practice and proper tool handling. In the human hand, the sense of touch is most prominent in the fingertips.

**When holding contact measuring tools lightly by the fingers, it is possible to “feel” extremely slight differences in dimension.**

Therefore, a contact measuring tool should be properly balanced in the hand and held lightly and delicately in such a way as to bring the fingers into play in handling or moving the tool. If the tool is clumsily or harshly grasped, the sense of touch or “feel” is greatly reduced.

## Estimation

Sight and touch are frequently combined by the skilled worker to estimate measurements finer than the graduated limits of a tool. For example, on the average micrometer graduated to read in thousandths of an inch, the space between the smallest graduations of the thimble is approximately 1/16 inch. Variations in size much smaller than the thousandth of an inch can readily be felt and judged by eye with reasonable accuracy. It is, of course, always best practice to work within the limits for which a measuring tool is designed, but when circumstances make it necessary, it is possible to extend the limits by estimating subdivisions of the smallest graduations in simple fractions such as 1/2, 1/3, 1/4, etc.



Although “feel” is important in adjusting a micrometer to measure the work, actual size is read directly from graduations on the sleeve and the thimble.

## Care of Tools

Precision measuring tools should be handled with the greatest of care. Good tools will stand a lifetime of use, but the accuracy of even the finest tool can be quickly impaired by careless treatment. Avoid scratches or nicks that obscure graduations or distort contact surfaces. Tools should be wiped clean of fingerprints after use and kept in separate boxes or cases.



A high grade instrument oil should be regularly applied to precision tools to lubricate their mating parts. Starrett Tool and Instrument Oil is an extra fine lubricant used in our own factory to lubricate and protect Starrett tools in production. Starrett M1® Lubricant prevents rust and corrosion. It leaves a micro-thin, air-tight coating that provides lasting protection on exterior surfaces.



A high grade instrument oil, such as Starrett M1® Lubricant, should be regularly applied to all precision tools.



## Linear Measurements

**Linear Measurements** on flat surfaces are perhaps the most common measurements. Linear measurements can be divided into three categories:

1. Coarse measurements with tools that are accurate between 1/64 inch (.0156mm) and a hundredth of an inch (.010mm).
2. Precision measurements are accurate to thousandths (.001) or ten thousandths (.0001) of an inch and, with proper tools, to millionths (.000001) of an inch.
3. In the metric system, accuracies to hundredths (.01 mm) or thousandths (.001 mm) of a millimeter and, with proper tools, of 30 millionths (.00003mm) of a millimeter are possible.



**A wide variety of tools are available for linear measurement as illustrated here.**

The tool used varies with the size of the dimension, the nature of the work and the degree of accuracy required. It may range from a steel tape, rule, divider or trammel, to a micrometer, Vernier caliper, dial indicator or electronic gage. The measurement may be made directly, as with a micrometer or Vernier caliper, or it may be made indirectly by comparison with a separate standard or gage blocks, using a surface gage, height gage or test indicator, depending on the level of accuracy required, to transfer the measurement. Many related tools such as straight edges, steel squares and protractors are used in conjunction with linear measuring tools to determine flatness, straightness, squareness and angularity.

**For Round Work**, measurements are usually made by contact, using tools with contact points or surfaces such as spring calipers, micrometers, Vernier calipers and dial gages. Contact measurements are made in two ways:

1. By pre-setting the tool (a dial snap gage, for example) required dimension, using a micrometer, gage blocks or other standard, and then comparing the set dimensions with the actual size of the work.
2. The reverse of this method, setting the contact points to the surfaces of the work and directly reading the size from a micrometer, Vernier caliper or dial gage.

The first method is often used where repeated tests must be made such as in machining a piece to a given size or when checking the same dimension on a number of parts.



**Measuring round work, a crankshaft journal, with an outside micrometer.**

## Steel Rules and Related Tools

The rule is a basic measuring tool from which many other tools have been developed. Rules range in size from as small as one-quarter inch in length for measuring in grooves, recesses and key-ways to as much as twelve feet in length for large work. Steel rules are graduated in the English (Inch) or Metric system and sometimes scales for both systems are provided on a single rule. They can be graduated on each edge of both sides and even on the ends. English graduations are commonly as fine as one-hundredth (.010) inch in decimals or one sixty-fourth (1/64) inch in fractions. Metric graduations are usually as fine as one-half millimeter (0.50mm). Starrett rules are graduated to agree with standards calibrated by the National Institute of Standards and Technology (NIST).

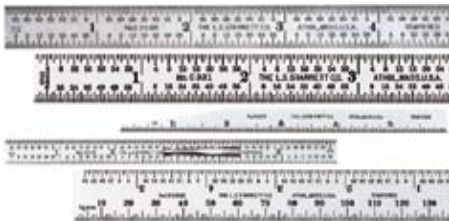

The steel rule is one of the basic measuring tools. Various types in English and metric are shown.

**Steel Rule Variations** The 6-inch rule is the most convenient length for carrying. A spring tempered rule is desirable since it is both thin and flexible yet has ample stiffness to provide a straight measuring edge. Small rules are available with a tapered end for measuring in small holes, narrow slots, from shoulders, etc.

The Hook feature is available on many rules. It provides an accurate stop for setting calipers, dividers, etc., and can also be used for taking measurements where it is not possible to be sure that the end of the rule is even with the edge of the work.



Starrett H604R-6 Spring Tempered, 6 inches long. Graduations in 8ths, 16ths, quick reading 32nds and 64ths. The single hook is hardened and may be reversed or removed entirely by a slight turn of the eccentric stud.



Starrett No. C331 is a fully flexible, 150mm long steel rule — the metric equivalent of the machinist's 6-inch English reading pocket rule. It is numbered consecutively every 10mm with staggered graduations for easy reading. Graduations are in 32nds and 64ths on one side; millimeters (1.0mm) and half-millimeters (0.5mm) on the reverse side. All four edges are graduated from the same end.

## Measuring Tapes



**Steel Long-Line Tapes**

Measuring tapes are a logical extension of a graduated measuring tool beyond the practical limits of a steel rule. Long line tapes are available in lengths up to 100 feet and are still accurate. Every Starrett tape is made to bench standards certified for accuracy by the United States Government – National Institute of Standards and Technology, Washington, D.C. Standard for temperature is 68 degrees Fahrenheit; coefficient of expansion is 0.00000645" per inch per degree F, or 0.00774" per degree per 100 feet; standard tension for steel tapes up to 100 feet long supported horizontally throughout is 10 pounds.



**Magnesium Tape**

**ControLok® Tape**

**ProSite® Tape**

Like steel rules, long-line tapes are available in a choice of graduations. Grey polymer coated or yellow baked enamel finish tape lines with quick-reading graduations, foot figures and 16-inch stud centers marked in red make reading easy and give long tape life. Steel tapes are also available with standard graduations on one side and special graduations in consecutive diameter graduations to 64ths or 100ths on the reverse. This allows for direct reading of diameter by measuring circumference.

Starrett ProSite® Series tapes are ergonomically shaped with an over-molded grip for easy handling. ControLok® Tapes automatically lock and retract. Magnesium Case Measuring Tapes are lightweight, incredibly strong and are a top-of-the-line professional tape.

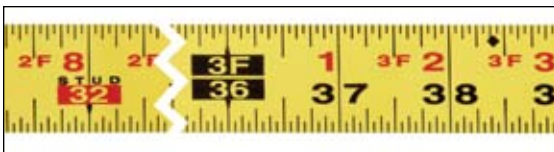

Quick-reading figures on a steel tape eliminate confusion and errors. Foot figures in red plus red foot figures before every inch mark. Red flag every 16 inches shows stud centers (Inch reading).

## Slide Calipers

Slide calipers are essentially an extension of the steel rule that ensures greater accuracy by aligning the graduated scale with the edges or points to be measured. They add a pair of jaws (head) to the rule – one jaw fixed at the end and the other movable along the scale.

The slide is graduated to read inside or outside measurements. They have a knurled clamping screw to lock the slide to the desired setting. The configuration allows the tool to be operated with one hand, leaving the other hand free to hold the workpiece.

Starrett No. 120  
6" Dial Caliper.

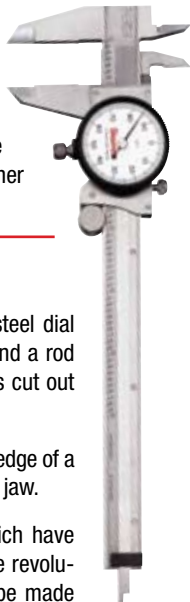

## Dial Slide Calipers

A most versatile and easy to read instrument, this four-way stainless steel dial caliper has knife edge contacts for inside and outside measurements, and a rod connected to its slide for obtaining depth dimensions. The rod contact is cut out to provide a nib for gaging small grooves and recesses.

By placing the front end of the reverse side of the movable jaw against the edge of a work piece, parallel lines may be scribed against the front end of the fixed jaw.

All readings are taken directly from the dial indicator and the bar, which have sharp clear dial graduations of .001" or 0.02mm – .100" or 2mm in one revolution, and .100" or 1mm on the satin finished bar. Measurements may be made with one hand, a thumb roll being provided for fine adjustment. Knurled thumb screws lock the movable jaw and adjustable indicator dial at any setting. With the addition of a depth attachment, the dial caliper becomes a convenient and easy to use depth gage. Dial calipers are available in 6, 9 and 12" ranges (150, 225, and 300mm) with depth capabilities.

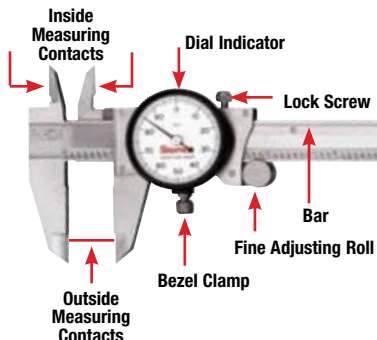

Outside measurement.



Inside measurement.



Depth measurement.



Measuring from shoulder.

## Electronic Slide Calipers

Microprocessing-based slide calipers directly read English or metric measurements and instantly convert from one to the other. They have easy-to-read displays that require no interpretation and therefore are less error-prone. Some, such as the Starrett 797 Series have output ports allowing transmission of measurement data through the DataSure Wireless Data Collection System or older-technology cable-based systems for Statistical Process Control (SPC) and similar application where data must be recorded.



Starrett No. 797 Electronic Caliper with a DataSure Endnode attached to its output port.

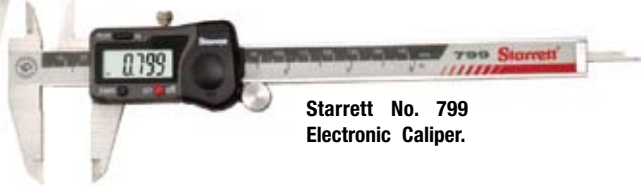

Starrett No. 799 Electronic Caliper.

**797 Series Electronic Calipers with IP65 protection and output** protects against foreign matter in hostile shop environments. It has large, easy-to-read LCD display, in/mm conversion, resolution of .0005" (0.01mm), an RS232 output port for data transmission and ranges of up to 12" (300mm).

**799 Series Electronic Calipers** are available in five sizes to 40" (1000mm); resolution of .0005" (0.01mm); a linear accuracy of  $\pm 0.001$ " ( $\pm 0.03$ mm) on 6" model. They have easy to read LCD, auto shut-off, in/mm conversion, and zero at any position.

---

## Vernier Slide Calipers

Vernier slide calipers are the oldest type and most accurate slide calipers. They require more skill to use than dial or electronic types and are described below in the Vernier Tools section.

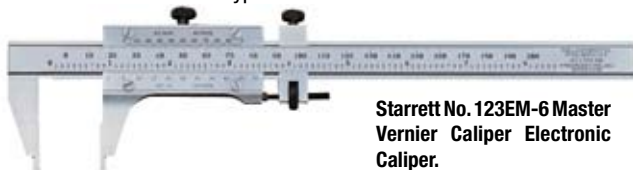

Starrett No. 123EM-6 Master Vernier Caliper Electronic Caliper.

## Traditional Calipers and Dividers

Various types of calipers and dividers are available for contact measurement. They are particularly useful for measuring distances between or over surfaces or for comparing dimensions or sizes with standards such as graduated rules. While they are sometimes used for checking work in a lathe, calipers should never be used while work is turning. Not only are the readings inaccurate, but there is always the possibility of having the tool torn out of the hand.



**Calipers** with legs shaped either for inside or outside measurements are made in “spring bow” style, with an adjusting nut and screw working against the tension of a spring; in “firm joint” style where the tension of a nut and stud provides sufficient friction to hold the legs in any set position; and in “lock joint” style with a knurled nut that may be loosened for free movement of the legs and tightened to lock the setting. Transfer calipers are variations of lock joint calipers with a stud or stop on a freely moving leg fitted into a slot or against a stop on an auxiliary leaf. The free leg can be moved in or out to clear collars, flanges or other obstructions and then returned to the original setting against the stop to make the reading.

**Dividers** are used for measuring dimensions between lines or points, for transferring lengths taken from a steel rule, and for scribing circles or arcs. The tips are sharp, hardened points at the ends of straight legs and close measurements are made by visual comparison rather than by feel. Dividers are restricted in range by the opening span of the legs and become less effective for scribing and similar uses when the points are sharply inclined to the surface worked upon.

**Hermaphrodite Calipers** combine a straight divider leg and a curved caliper leg and are used for scribing parallel lines from an edge or for locating the center of cylindrical work.

## How to Transfer Measurements

**Transferring Measurements** can be a delicate job. One of the most common of all tools for transferring measurements is the bow caliper. These are made with the legs curved inward or outward for making outside or inside measurements. When the calipers are set to the work, care should be taken to bring the points into contact without excessive pressure that might cause the legs to spring and introduce an element of error. The measurement is then transferred to a steel rule. In this way, it is possible to transfer lengths with an error of less than 0.002". More accurate readings can be obtained when a micrometer or Vernier caliper is used to measure the distance between points of the spring caliper. It is here that the sense of "feel" becomes important in judging measurements precisely. Differences in size too small for the eye alone to detect can be readily felt as differences in the ease with which the tool slips over the work or between contacts of the standard. In setting calipers either to the work or to the standard, a firm but not hard contact is desirable. The feel of the slight resistance to movement of the contact points can be retained in the memory long enough for precise comparison between work and standard.

While it is possible in this way to transfer by feel a length with as small an error as one-quarter of one thousandth inch, sometimes it is impractical or can introduce an error. For that reason, machinists prefer to use tools which can be read directly in thousandths or ten-thousandths of an inch, such as micrometers or Vernier calipers. A sense of feel is important and developing the habit of using the same pressure for every measurement is imperative.



**Pre-setting outside calipers to a rule for a transfer measurement.**



**After establishing hole size with a telescoping gage, actual size is determined by measuring over the contacts with an outside micrometer.**



## Depth Gages

Depth Gages are an adaptation of the rule or Vernier scale for measuring the depth of holes, recesses, etc. They include a sliding stock or base set at right angles to the rule and with a means of clamping the slide to lock the reading. Another gage is a combination depth and angle gage. An optional hook on the rule is available to measure from an undercut or recess.



Vernier  
Depth  
Gage



Rule  
Depth  
Gage



Combination  
Depth and  
Angle Gage  
with Hook

Checking the depth of a blind hole with a depth gage.



## Electronic Depth Gage

The 3753 Electronic Depth Gage provides easy, accurate depth measurements of holes, slots and recesses. The 753 has a range of up to 0-12" (0-300mm); linear accuracy of  $\pm .001$ " ( $\pm 0.03$ mm) and resolution of  $.0005$ " (0.01mm) with output to SPC peripherals.



## Dial Depth Gage

A dial depth gage in either a 6" or 12" (150mm or 300mm) range is a quick and accurate method of measuring depth of holes, slots and recesses. Readings are taken directly from the rack and the dial indicator. Large openings can be measured using a 7" or 12" extension base, which can also be positioned to the right or left for off-center slots, close to shoulders and between obstructions. The removable hook permits readings from the edge of a work piece to edges of slots, shoulders, etc.





## Combination Sets

The basic combination set consists of a hardened steel graduated rule and movable combination square and miter head with spirit level and scriber. In itself, it is a most versatile and useful layout and measuring tool which can be used as a try square, miter, depth gage, height gage and level. The addition of a center head provides an easy means of locating the center of cylindrical or square work.

Protractor heads have revolving turrets with direct reading double graduations a full 0 to 180° in opposite directions. This permits direct reading of angles above or below the blade. Protractor heads are furnished as reversible type with shoulders on both sides of the blade or non-reversible type with a single shoulder. Both types are equipped with a handy spirit level.

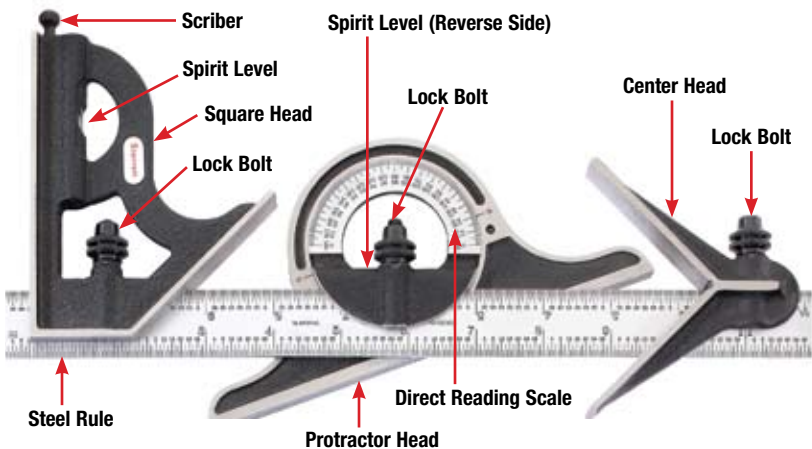

A captivated reversible lock bolt allows the blade to be turned over or end-to-end without removing the bolt and nut and insures true alignment of blade and heads. The heads slide smoothly to any position along the blade and may be removed so the square head (which has a spirit level) may be used to level work. The blade may then be used as a separate rule.

Square heads have a precision ground 90° square face and a 45° miter face and come with hardened scriber and spirit level (except No. 33J Series and 4" sizes). Center heads have accurately machined faces.

## Combination Set Applications



The protractor head on a combination set accurately and quickly checks angles.



The combination square used as a depth gage. A very handy application.



Scribing right angles and parallel lines using a combination square.



Center of round work can be accurately determined using the center head of the combination square.

## Micrometers

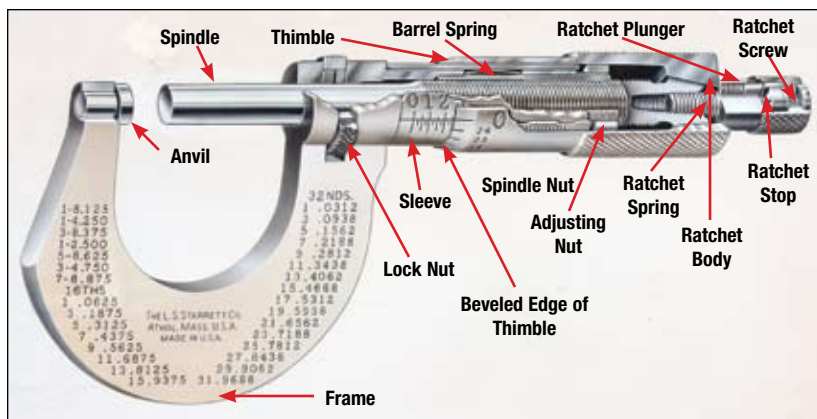

The first micrometers originating in France were rather crude. Laroy S. Starrett (1836-1922), founder of the L.S. Starrett Company, is responsible for the many improvements that make it the modern precision measuring tool that we know today. In effect, a micrometer combines the double contact of a slide caliper with a precision screw adjustment which may be read with great accuracy. It operates on the principle that a screw accurately made with a pitch of forty threads to the inch will advance one-fortieth (or .025) of an inch with each turn.

In the metric system the pitch of the screw is 0.5mm. Each turn will advance the screw 0.5mm so it will take 50 turns to complete the normal range of 25mm.

As the sectional view illustrates, the screw threads on the spindle revolve in a fixed nut concealed by a sleeve. On a micrometer caliper of one-inch capacity, the sleeve is marked longitudinally with 40 lines to the inch, corresponding with the number of threads on the spindle.

### **How to Read a Micrometer** **Graduated in Thousandths of an Inch (.001")**

Since the pitch of the screw thread on the spindle is  $1/40"$  or 40 threads per inch in micrometers graduated to measure in inches, one complete revolution of the thimble advances the spindle face toward or away from the anvil face precisely  $1/40$  or .025 of an inch.

The reading line on the sleeve is divided into 40 equal parts by vertical lines that correspond to the number of threads on the spindle. Therefore, each vertical line designates 1/40 or .025 of an inch and every fourth line, which is longer than the others, designates hundreds of thousandths. For example: the line marked "1" represents .100", the line marked "2" represents .200" and the line marked "3" represents .300", etc.

The beveled edge of the thimble is divided into 25 equal parts with each line representing .001" and every line numbered consecutively. Rotating the thimble from one of these lines to the next moves the spindle longitudinally 1/25 of .025" or .001 of an inch; rotating two divisions represents .002", etc. Twenty-five divisions indicate a complete revolution, .025 or 1/40 of an inch.

To read the micrometer in thousandths, multiply the number of vertical divisions visible on the sleeve by .025", and to this add the number of thousandths indicated by the line on the thimble which coincides with the reading line on the sleeve.

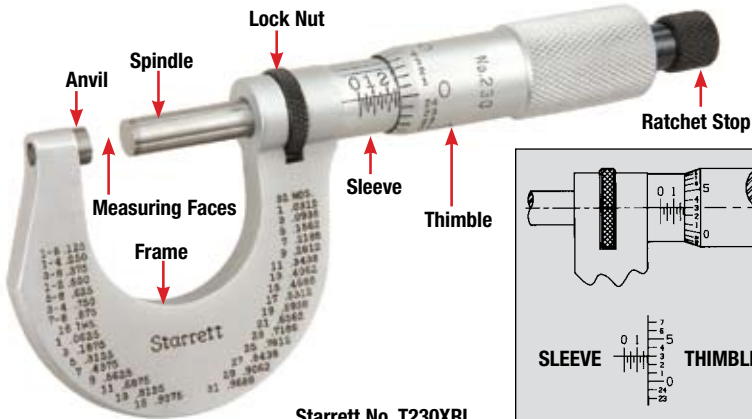

**Starrett No. T230XRL  
Outside Micrometer.**

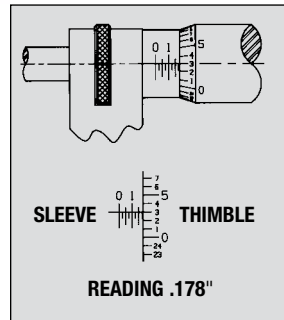

**Example:** refer to the illustration above:

The "1" line on the sleeve is visible, representing . . . . . 0.100"  
 There are 3 additional lines visible, each representing .025" . . . . . 3 x .025" = 0.075"  
 Line "3" on the thimble coincides with the reading line on the sleeve,  
 each line representing .001" . . . . . 3 x .001" = 0.003"  
 The micrometer reading is . . . . . 0.178"

An easy way to remember is to think of the various units as if you were making change from a ten dollar bill. Count the figures on the sleeve as dollars, the vertical lines on the sleeve as quarters and the divisions on the thimble as cents. Add up your change and put a decimal point instead of a dollar sign in front of the figures.

## How to Read a Micrometer Graduated in Ten-Thousandths of an Inch (.0001")

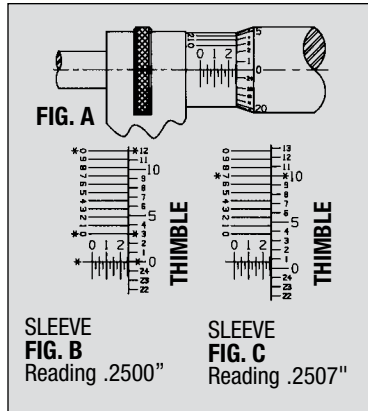
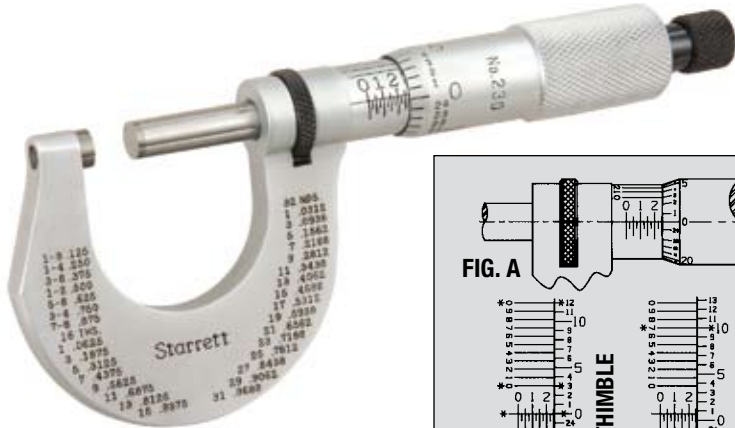

Once you have mastered the principle of the Vernier as explained on page 30, you will have no trouble reading a Vernier micrometer in ten-thousandths of an inch. The only difference is that on a Vernier micrometer, there are ten divisions marked on the sleeve occupying the same space as nine divisions on the beveled edge of the thimble. Therefore, the difference between the width of one of the ten spaces on the sleeve and one of the nine spaces on the thimble is one-tenth of a division on the thimble. Since the thimble is graduated to read in thousandths, one-tenth of a division would be one ten-thousandth. To make the reading, first read to thousandths as with a regular micrometer, then see which of the horizontal lines on the sleeve coincides with a line on the thimble. Add to the previous reading the number of ten-thousandths indicated by the line on the sleeve which exactly coincides with a line on the thimble.

In the above illustration (Fig. A & B), the 0 on the thimble coincides exactly with the axial line on the sleeve and the Vernier 0 on the sleeve is the one which coincides with a line on the thimble. The reading is, therefore, an even .2500". Figure C above, the 0 line on the thimble has gone beyond the axial line on the sleeve, indicating a reading of more than .2500". Checking the Vernier shows that the seventh Vernier line on the sleeve is the one which exactly coincides with a line on the thimble. Therefore, the reading is .2507".

## How to Read a Micrometer Graduated in Hundredths of a Millimeter (0.01mm)

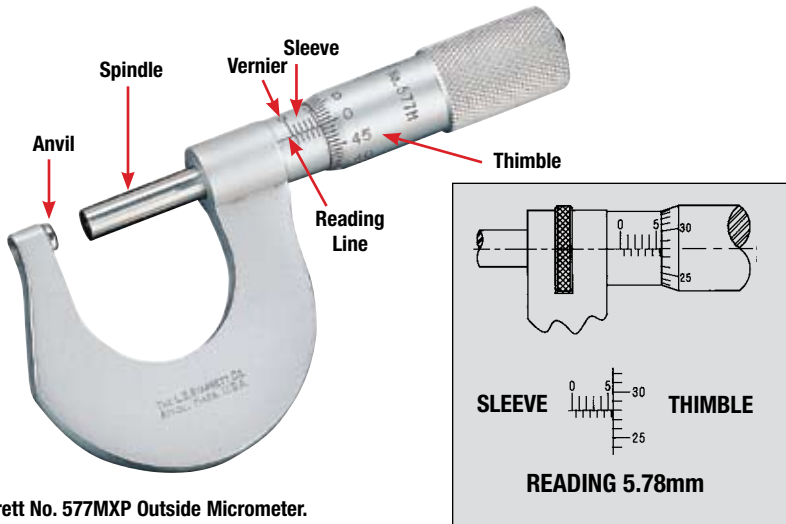

Starrett No. 577MXP Outside Micrometer.

Since the pitch of the spindle screw is one-half millimeter (0.5mm), one revolution of the thimble advances the spindle toward or away from the anvil the same 0.5mm distance.

The reading line on the sleeve is graduated in millimeters (1.0mm) with every fifth millimeter being numbered from 0 to 25. Each millimeter is also divided in half (0.5mm), and it requires two revolutions of the thimble to advance the spindle 1.0mm. The beveled edge of the thimble is graduated in 50 divisions, every fifth line being numbered from 0 to 50. Since one revolution of the thimble advances or withdraws the spindle 0.5mm, each thimble graduation equals 1/50 of 0.5mm or 0.01mm. Thus two thimble graduations equal 0.02mm, three graduations 0.03mm, etc.

### EXAMPLE

Referring to the picture and figure above:

The 5mm sleeve graduation is visible. . . . . 5.00mm

One additional 0.5mm line is visible on the sleeve . . . . . 0.50mm

Line 28 on the thimble coincides with the reading line on the sleeve, so  $28 \times 0.01\text{mm} =$  . . . . . 0.28mm

The micrometer reading is. . . . . 5.78mm

## How to Read a Vernier Micrometer Graduated In One Hundredths of a Millimeter (0.01mm) and in Two Thousandths of a Millimeter (0.002mm)

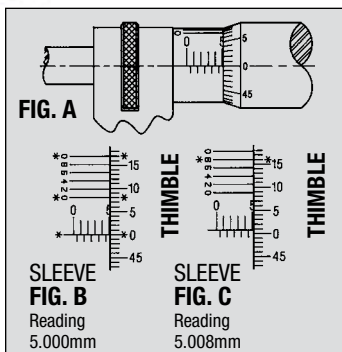
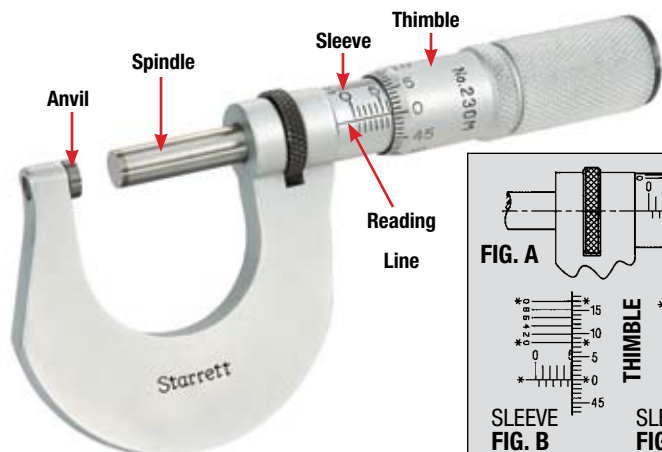

Starrett No. V230MXFL Outside Micrometer.

Metric Vernier micrometers are used like those graduated in hundredths of a millimeter (0.01mm), except that an additional reading in two-thousandths of a millimeter (0.002mm) is obtained from a Vernier scale on the sleeve.

The Vernier consists of five divisions, each of which equals one-fifth of a thimble division:  $1/5$  of 0.01mm or 0.002mm.

To read the micrometer, obtain a reading to 0.01mm in the same way shown on the previous page. Then see which line on the Vernier coincides with a line on the thimble. If it is the line marked 2, add 0.002mm; if it is the line marked 4, add 0.004mm, etc.

### EXAMPLE – Referring to figures A and B above:

The 5mm sleeve graduation is visible. . . . . 5.000mm

No additional lines on the sleeve are visible . . . 0.000mm

Line 0 on the thimble coincides  
with the reading line on the sleeve. . . . . 0.000mm

The 0 lines on the Vernier  
coincide with lines on the thimble . . . . . 0.000mm

The micrometer reading is. . . . . 5.000mm

### EXAMPLE – Referring to figure C above:

The 5mm sleeve graduation is visible. . . . . 5.000mm

No additional lines on the sleeve are visible . . . 0.000mm

Line 0 on the thimble lies below the reading line on the sleeve, indicating that a Vernier reading must be added.

Line 8 on the Vernier coincides  
with a line on the thimble . . . . . 0.008mm

The micrometer reading is. . . . . 5.008mm

## Using, Adjusting and Caring for Micrometers

For most measurements the micrometer is held as shown. The work is placed against the anvil with the spindle is turned down on the work with the thumb and index finger of the right hand. Caution: Do not force measurement – light contact pressure assures correct reading. After some practice, you will develop a measuring “feel” that will give your readings automatic accuracy.

Do not remove work from micrometer before taking reading. If reading cannot be seen without removing the micrometer, lock the spindle at the final setting with the lock nut and slide micrometer off work by the frame.



**Starrett friction thimble micrometers (illustrated) and ratchet stop give uniform contact pressure for correct readings every time, independent of “feel”.**



**Illustrated: Adjusting spindle play.**



**Illustrated: Adjusting for zero reading.**

Adjusting any micrometer can be done in two easy steps. To eliminate play in the spindle, back off the thimble, insert spanner wrench (furnished with micrometer) into the adjusting nut and tighten just enough to eliminate play. See illustration top left. To adjust zero reading, clean all dirt or grit from measuring faces by gently closing the spindle to the anvil with a clean piece of paper between them. Pull the paper out with pressure applied, then close the faces using “feel” (friction thimble or ratchet stop, if so equipped), now insert spanner wrench in the small slot of the sleeve as shown lower left. Then turn sleeve until its zero line coincides with zero line on thimble.

Caring for your micrometer requires little effort and pays off in long, accurate life. Be sure to check your micrometer periodically for accuracy, making adjustments as required. An occasional drop of Starrett Precision Instrument Oil on spindle and spindle threads also assures free running performance.

Always wipe off your micrometer before putting it away – never use an air hose as this is apt to force dirt and grit into spindle threads. Keep your micrometer in its case when not in use.



## Electronic Micrometers

Over the past couple of decades, microprocessing-based on electronic tools have become available. These have the advantage of being direct reading in either the English or metric, usually with a button that allows instant conversion between the two. They provide fast, easy to read displays that require no interpretation and therefore are less error-prone. They also have output ports allowing transmission of measurement data through the DataSure Wireless Data Collection System or older-technology cable-based systems for Statistical Process Control (SPC) and similar application where data must be recorded.

**Electronic Micrometers** combine these benefits with a resolution of fifty millionths of an inch. inch/millimeter conversion, plus the rugged construction, smooth operation, “feel” and balance of Starrett mechanical micrometers. The Starrett line of electronic micrometers includes outside, special function, internal micrometers and micrometer heads.

**The 795/796 Series** are the latest generation electronic outside micrometers from Starrett. They have a resolution of .00005" (0.001mm), an accuracy of  $\pm 0.001$ " ( $\pm 0.002$ mm) and a range from 0" to 1". The 795 Series includes output while the 796 micrometers do not.

Both 795 and 796 Micrometers provide IP67 protection against shopfloor contaminants.



**Starrett 795XFL-1 Electronic Outside Micrometer with IP67 level of protection.**

---

## IP 67 Protection

According to IEC529, IP67 stands for protection against coolant, water, chips, dirt and other contaminants as follows:

The first number “6” identifies protection against ingress of dust.

The second number “7” identifies protection against water by full immersion in between 15cm and 1meter of water for 30 minutes.



## How to Use a Depth Micrometer

A depth micrometer, as the name implies, was designed to measure the depth of holes, slots, recesses, keyways, etc. Available in both standard or digital readout.

The tool consists of a hardened, ground and lapped base combined with a micrometer head. Measuring rods are inserted through a hole in the micrometer screw and brought to a positive seat by a knurled nut. The screw is precision ground and has a one-inch movement. The rods are furnished to measure in increments of one inch. Each rod protrudes through the base and moves as the thimble is rotated.

The reading is taken exactly the same as with an outside micrometer, except that sleeve graduations run in the opposite direction. In obtaining a reading using a rod other than the 0-1", it is necessary to consider the additional rod length. For example, if the 1-2" rod is being used, one inch must be added to the reading on the sleeve and thimble.

Before using the depth micrometer, be sure that base, end of rod and work are wiped clean, and that rod is properly seated in micrometer head. Hold base firmly against work as shown below, and turn thimble until rod contacts bottom of slot or recess. Tighten lock nut and remove tool from work to read measurement.

Adjustment to compensate for wear is provided by an adjusting nut at the end of each rod. Should it become necessary to make an adjustment of a rod, back off the adjusting nut one-half turn before turning to new position, then check against a known standard such as a Webber gage block.



**Starrett No. 440, 445  
Series Micrometer  
Depth Gage.**



**Starrett No. 446 Series  
Digital Micrometer  
Depth Gage.**



**Starrett No. 749  
Series Electronic  
Depth Gage with output.**



## How to Use an Inside Micrometer

**Inside Micrometers** are an application of the micrometer screw principle to adjustable-end measuring gages. The distance between ends or contacts is changed by rotating the thimble on the micrometer head up to the extent of screw length, usually either one-half or one inch. Greater distances are obtained by means of extension rods and suitable spacing collars or gages which slide onto the holding end of the interchangeable rods in various combinations to cover the total range of the tool.



Inside micrometers are a little more challenging to use than outside micrometers. With spherical contact points more practice and caution is needed to “feel” the full diametral measurement. Since one contact point is generally held in a fixed position, the other must be rocked in different directions to be sure the tool is spanning the true diameter of a hole or the correct width of a slot. In place of a locknut, a friction drag is noticeable on the thimble.



Starrett No. 124C 8"-32" Inside Micrometer.

**Fixed Range Inside Micrometers** Starrett fixed range inside micrometers are available in either 1 inch or 2 inch range and up to 12 inches in length. Insulating handles minimizes possible expansion by heat when held in the hand.

Measuring rods can be individually adjusted to take up wear, and the micrometer head is also adjustable for wear on its screw. A knurled extension handle is available for obtaining inside measurements in hard-to-reach locations.

**End Measuring Rods** Precise setting of the slides and table on jig borers and other machine tools are held to a high degree of accuracy by means of precision end-measuring rods. Each set consists of two micrometer heads graduated in “tenths” (.0001") together with a series of hardened, ground and lapped measuring rods.



Starrett No. 824C 5-6 Inch Inside Micrometer.

## Quick Measurements

Micrometers are available with either a friction thimble or ratchet stop designed so that the spindle will not turn after more than a given amount of pressure is applied. This feature is of value when a number of measurements are made or when the measurements are made by more than one person with the same caliper. With the ratchet type, when the anvil and spindle are in proper contact with the work, the ratchet slips by the pawl and no further pressure is applied. The ratchet stop is incorporated in a small auxiliary knurled knob at the end of the thimble. The friction type mechanism is built into the thimble as a thimble friction where it reduces the required span of thumb and fingers and makes it easier to use the micrometer with one hand. A lock nut is provided for retaining a reading.



**Ratchet stop on micrometer ensures consistent gaging pressure.**



**Friction thimble permits one-hand operation of micrometer and uniform contact pressure.**

## Digital Micrometers

Digital micrometers make readings faster and easier for every machinist, regardless of experience. The frame-mounted counter saves handling time since it can be read without removing your fingers from the thimble or the micrometer from the work.



**Starrett No. 216 Series Digital Micrometer.**

## Micrometer Heads



**Starrett No. 762 Electronic Micrometer Head.**

Electronic applications, machine tools, special gages and tooling often specify micrometer heads where micrometer accuracy in settings and adjustment is required. Available in ranges of 0 to 1/4 inch, 0 to 1/2 inch, 0 to 1 inch and 0 to 2 inches with graduations in thousandths or ten-thousandths of an inch or metric equivalents with satin-chrome finish or made of stainless steel.



**Starrett No. 262RL Micrometer Head with Non-Rotating Spindle.**



**Starrett No. 363 Series Digital Micrometer Head.**

## Bench Micrometers

The bench micrometer is a fine precision instrument ideal for use either in the shop or inspection laboratory. It can be used for comparator measuring to 50 millionths of an inch (.000050") or for direct measuring to ten-thousandths of an inch (.0001"). Work lengths

from 0 to 2 inches can be measured. At the end of the base is a movable anvil which actuates a dial indicator graduated in 50 millionths of an inch (.000050"). The anvil actuates the indicator through a motion transfer mechanism which has a contact pressure adjustment from 8oz. to 3lbs., and can be retracted by a lever for repeated measurement. A heavy-duty micrometer head to the right of the base reads directly in ten-thousandths of an inch (.0001") with a two-inch range. An adjustable worktable centered beneath the anvil and spindle can be positioned to accurately align work by adjusting the table and locking it with the screw provided. It can be adapted for electronic readout using the No. 776 series Gage-Chek™ Amplifier with the No. 673A Adaptor for the No. 715-2 Cartridge-Type Electronic Gaging Head (see page 57), for Statistical Process Control (SPC) applications.



Starrett No. 673 Bench Micrometer.

## Micrometers for Specialized Applications

Micrometers are available for special purposes such as: Mul-T-Anvil micrometers with vise-type frame and interchangeable anvils for measuring tubing, hole to an edge, thickness of screw heads; V-Anvil micrometers for checking out-of-roundness of centerless grinding work and measuring odd-fluted cutting tools; disc-type micrometers for measuring thin, closely spaced sections; blade-type micrometers for narrow grooves and slots; sheet

metal micrometers with deep U frame which permits gaging over beading or flanges or at any point on a surface, including near the center of the sheet; screw thread micrometers with a pointed spindle and a V-anvil for measuring threads; ball-anvil micrometers and tube micrometers for measuring tubular or curved surfaces and paper-gage micrometers. Micrometers are also made with capacities up to 60 inches and more.



## Vernier Tools

The Vernier was invented by a French mathematician, Pierre Vernier (1580-1637). The Vernier caliper consists basically of a stationary bar and a movable Vernier slide assembly. The stationary rule is a hardened graduated bar with a fixed measuring jaw. The movable Vernier slide assembly combines a movable jaw, Vernier plate, clamp screws and adjusting nut.

The Vernier slide assembly moves as a unit along the graduations of the bar to bring both jaws in contact with the work. Readings are taken in thousandths of an inch by reading the position of the Vernier plate in relation to the graduations on the stationary bar.

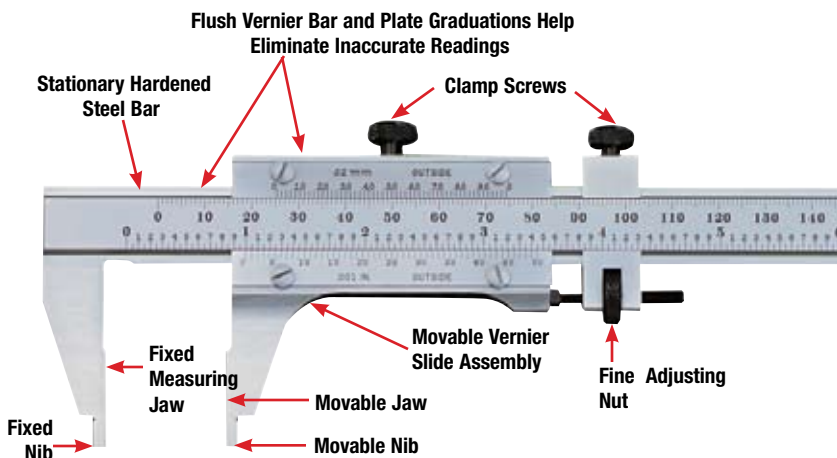

Starrett Vernier gages feature 50 divisions, with widely spaced, easy-to-read graduations allowing fast, accurate and simplified readings that can be read without a magnifying glass.

The Vernier principle is applied to many Starrett tools such as Vernier Height Gages, Vernier Depth Gages, Vernier Protractors, Gear Tooth Vernier Calipers, etc.

## How to Read Vernier Calipers (Inch)

The bar is graduated into twentieths of an inch (.050"). Every second division represents a tenth of an inch and is numbered.

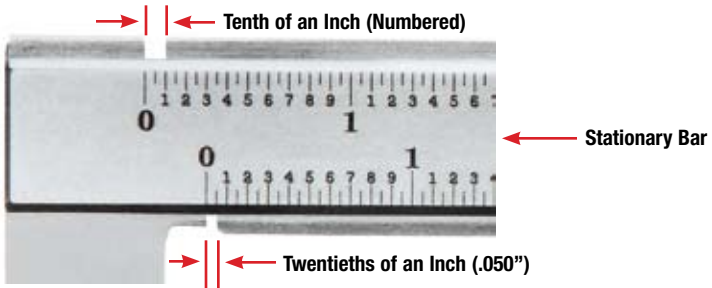

The Vernier plate is divided into fifty parts and numbered 0, 5, 10, 15, 20, 25...45, 50. The fifty divisions on the Vernier plate occupy the same space as forty-nine divisions on the bar.

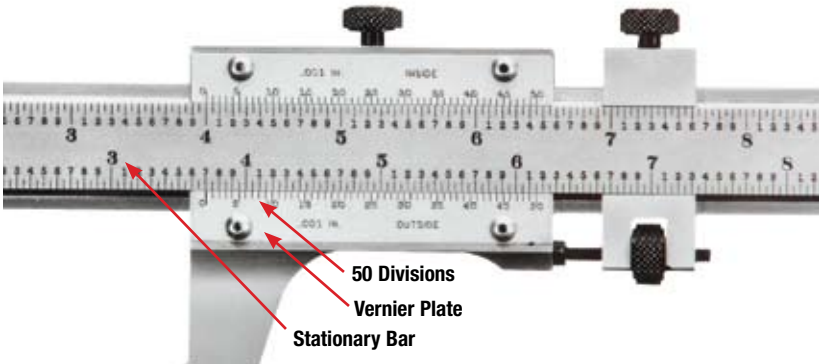

The difference between the width of one of the fifty spaces on the Vernier plate and one of the forty-nine spaces on the bar is therefore 1/1000 of an inch (1/50 of 1/20). If the tool is set so that the 0 line on the Vernier plate coincides with the 0 line on the bar, the line to the right of the 0 on the Vernier plate will differ from the line to the right of the 0 on the bar by 1/1000; the second line by 2/1000 and so on. The difference will continue to increase 1/1000 of an inch for each division until the 50 on the Vernier plate coincides with the line 49 on the steel rule.

## How to Read Vernier Calipers (Inch) (Continued)

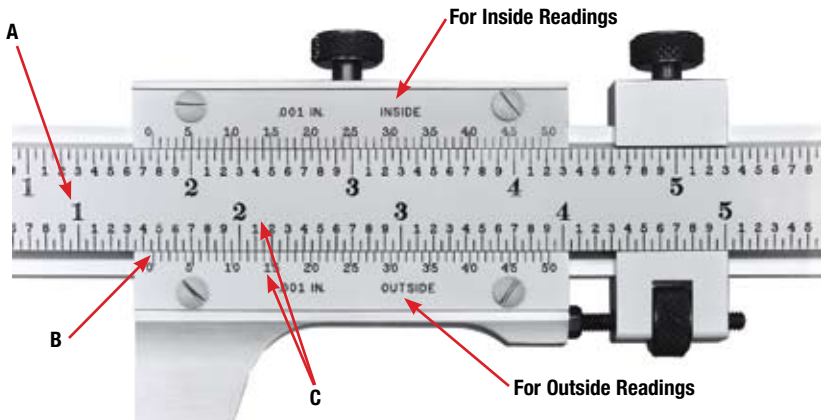

To read the tool, note how many inches, tenths (or .100) and twentieths (or .050) the mark on the Vernier plate is from the 0 mark on the bar.

Then note the number of divisions on the Vernier plate from the 0 to a line which EXACTLY COINCIDES with a line on the bar.

**EXAMPLE:** In the above illustration for outside measurements the Vernier plate has been moved to the right one inch and four hundred and fifty thousandths (1.450") as shown on the bar, and the fourteenth line of the Vernier plate EXACTLY COINCIDES with a line, as indicated on the illustration above. Fourteen thousandths of an inch (.014") are, therefore, to be added to the reading on the bar and the total reading is one and four hundred and sixty-four thousandths inches (1.464").

### You Add to Get Your Measurement

- A. 1.000" on the bar
- B. 0.450" also on the bar
- C. 0.014" on the Vernier plate (outside)  
1.464" is your measurement



## How to Read Metric Vernier Calipers

Each graduation on the bar is 1.00mm. Every tenth graduation is numbered in sequence – 10mm, 20mm, 30mm, 40mm, etc. – over the full range of the bar. This provides for direct reading in millimeters.

The Vernier plate is graduated in 50 parts, each representing 0.02mm. Every fifth line is numbered in sequence – 0.10mm, 0.20mm, 0.30mm, 0.40mm, 0.50mm – providing for direct reading in hundredths of a millimeter.

To read the gage, first count how many mm's lie between the 0 line on the bar and the 0 line on the Vernier plate. Then find the graduation on the Vernier plate that EXACTLY COINCIDES with a line on the bar and note its value in hundredths of a millimeter.

Add the Vernier plate reading in hundredths of a mm to the number of mm's you counted on the bar. This is your total measurement.

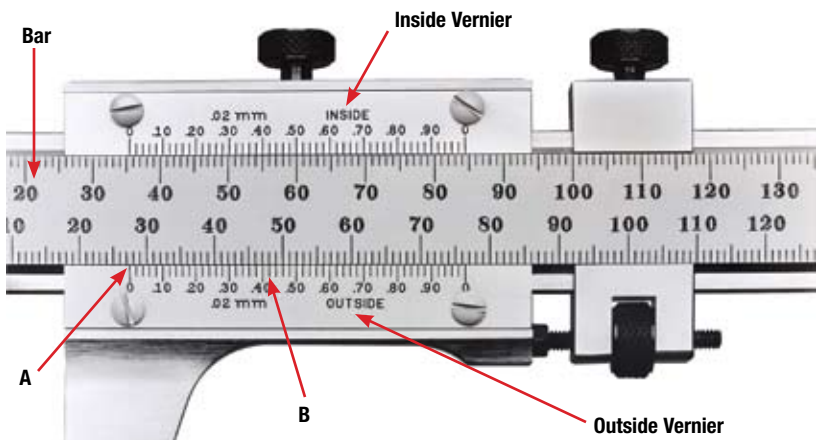

### You Add to Get Your Measurement

- A. 27.00mm on the bar
  - B. 0.42mm on the Vernier plate
- 27.42mm is your measurement

## Vernier Gauge, Inside and Outside Measurements

If you are using a Starrett No. 123 (English) Vernier Gauge, the same procedure is used for obtaining inside measurements as for outside measurements, however the top row of measurements are to be used.

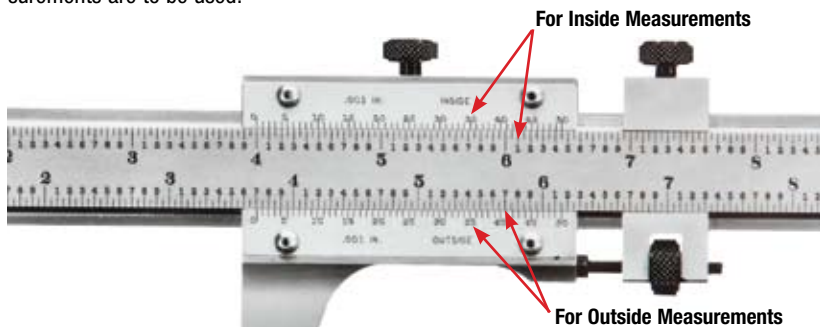

The above also applies if you are using a Starrett No. 123M (Metric) Vernier Gauge. The top row of measurements is for inside work and the bottom row is for outside work.

Starrett's No. 123E&M Vernier Gauge combines both Inch and Metric graduations on one gage. The top row on the bar and Vernier plate have Metric graduations. The bottom row on the bar and Vernier plate have Inch graduations. Both these scales can be used for direct reading for outside dimensions only.

For inside measurements it is necessary to add the width of the closed contacts to your dimension to arrive at the correct and complete measurement. The minimum measurement "A" is .250" (6.35mm for metric) for a Starrett No. 123E&M-6" Vernier Caliper. It is .300" (7.62mm for metric) for a Starrett No. 123E&M-12" and No. 123E&M-24" series.

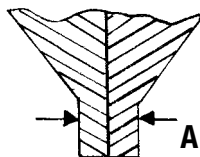

(Closed Contacts)

## Fine Adjustment

After bringing the measuring contacts to the work by sliding the movable jaw along the steel rule, tighten the fine adjustment clamp screw. Rotate the fine adjusting nut to bring the measuring contacts into final position against the work. Tighten the lock screw to clamp the sliding Vernier scale into position.

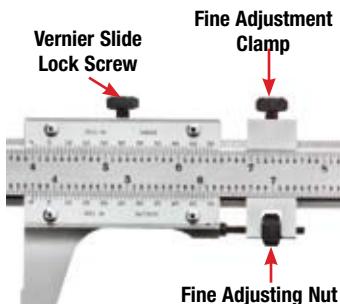

## ***Indentations for Setting Dividers or Trammels***

On the reverse side of the Vernier gage is a set of center points, one on the bar and one on the Vernier slide. By opening the Vernier gage to the required dimension, these two points can be an extremely quick, efficient and exacting means of setting your dividers or trammels to the proper dimension required. Measuring points or dimensions can be picked up by dividers or trammels and transferred by adjusting the Vernier caliper until the points of the divider or trammels fit into the indentations on the Vernier. The user can then read the Vernier, giving a more precise reading than if a rule were used.



---

## ***Caring for Vernier Gages***

A Vernier gage should be handled gently, but firmly and never forced in obtaining measurements. Bring the movable contact surface as close to work as possible by hand before using fine adjustment nut. Keep work and gage measuring surface free of dirt and grit to prevent inaccuracy and damage to the precision lapped surfaces. Wipe gage carefully after use and store in case with clamp screws loosened.

When a Vernier gage is temporarily set down on the bench be sure it lies flat and well away from the edge.

Check Vernier gage periodically for accuracy at the zero line. In the case of the Vernier caliper and gear tooth Vernier calipers, bring the nibs together and check alignment of zero lines on the bar and sliding Vernier.

Vernier depth gages are checked by placing base on surface plate and lowering blade until it too contacts the surface plate.

Because of precision fitting of slides, an occasional drop of Starrett Precision Oil should be used for free running performance. Never use emery cloth to polish gage contact surfaces or attempt to adjust gage for wear.



## Bevel Protractor with Vernier

The Universal Bevel Protractor with Vernier measures any angle to 1/12 of a degree or 5 minutes. Blade and dial may be rotated as a unit to any desired position and locked in place by means of the dial clamp nut. The ultra sensitive adjustment permits very accurate settings. The blade may be extended in either direction and locked against the dial by tightening the blade clamp nut which operates independently from the dial clamp nut. The protractor dial is graduated 360°, reading 0-90°, 90°-0, 0-90°, 90°-0. Each ten degrees is numbered, and each five degrees is indicated by a line longer than those on either side of it. The Vernier plate is graduated so that 12 spaces on the plate occupy the same space as 23 spaces on the disc of the protractor.

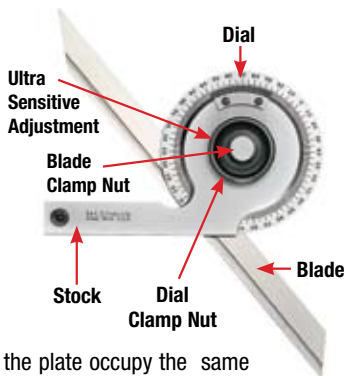

The difference between the width of one of the 12 spaces on the Vernier and two of the 23 spaces on the disc of the protractor is therefore 1/12 of a degree, or 5 minutes (5'). Each space on the Vernier is 1/12 of a degree, or 5 minutes (5') shorter than 2 spaces on the disc. The Vernier plate has clear figures each third space. These figures represent minutes. When the 0 line of the Vernier plate COINCIDES EXACTLY with a graduated line on the disc of the protractor, the reading is exact in whole degrees. When the 0 line of the Vernier plate does not coincide exactly with a graduated line of the disc of the protractor, then find the line on the Vernier that does COINCIDE EXACTLY with a line on the disc of the protractor. This line on the Vernier indicates the number of twelfths of a degree or 5 minutes (5') that should be added to the reading in whole degrees.



Reading: 50° 20'

In order to read the protractor, note on the disc the number of whole degrees between 0 on the disc and 0 on the Vernier. Then count in the same direction the number of spaces from 0 on the Vernier to a graduated line that does coincide with a line on the disc. Multiply this number by 5 and the product will be the number of minutes that should be added to the number of whole degrees.

**Example:** In the illustration above, the zero on the Vernier scale lies between the “50” and “51” on the protractor dial to the left of the zero, indicating 50 whole degrees. Also reading to the left, the 4th line on the Vernier scale coincides with the “58” graduation on the protractor dial as indicated by the arrows and therefore 4 x 5 minutes or 20 minutes are to be added to the number of degrees. The reading of the protractor, therefore, is 50 degrees and 20 minutes (50° 20'). The Vernier protractor can also be used as an accessory to the master Vernier height gage when clamped by its stock.

## Vernier Depth Gage

The Vernier depth gage differs slightly from the Vernier caliper and height gage in that the slide Vernier assembly remains fixed while the steel rule is moved to obtain measurements in thousandths of an inch. The Vernier slide also forms the base which is held on the work by one hand while the blade is operated with the other.

Measuring a dimension is similar to working with a Vernier caliper gage. After the blade is brought into contact with the bottom of a slot or recess the clamp screw adjacent to the fine adjusting nut is locked. Then the fine adjusting nut is turned to obtain an exact measurement, which is then locked in position by clamp screw beside Vernier plate.

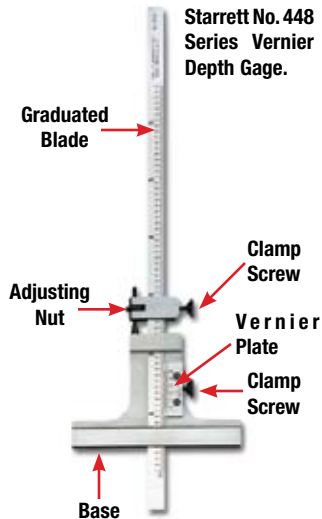

## Gear Tooth Vernier Caliper

The gear tooth Vernier caliper measures chordal thickness, or thickness at the pitch line of a gear tooth to one thousandth of an inch (.001"). Its construction combines in one tool the function of both Vernier depth gage and Vernier caliper. The vertical slide is set to depth by means of its Vernier plate fine-adjusting nut so that when it rests on top of the gear tooth,

the caliper jaws will be correctly positioned to measure across the pitch line of the gear tooth. The horizontal slide is then used to obtain the chordal thickness of the gear tooth by means of its Vernier slide fine-adjusting nut.

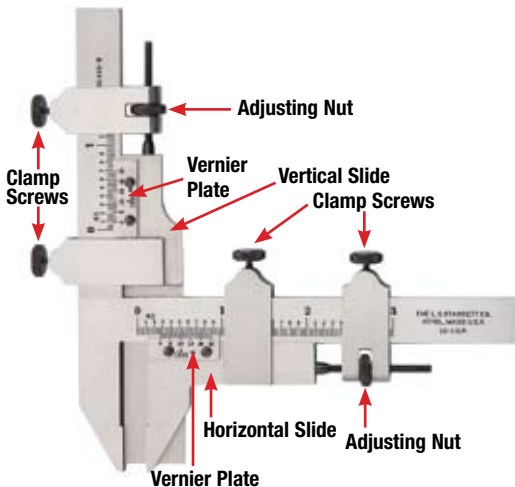

The procedure for reading these gages is the same as for Vernier calipers.

Figures for determining depth settings on the vertical slide and caliper readings on the horizontal slide are tabulated on the following page.

## Chordal Thickness of Gear Teeth Bases of 1 Diameter

S = Module or addendum, or distance from top to pitch line of tooth

s" = Corrected S = H + S

t" = Chordal thickness of tooth

H = Height of arc

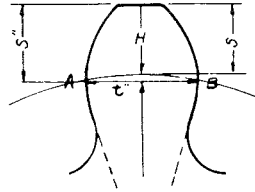

When using gear tooth Vernier caliper to measure coarse pitch gear teeth, the chordal thickness  $t''$  must be known, since  $t''$  is less than the regular thickness  $AB$  measured on the pitch line. In referring to the table below, note that height of arc  $H$  has been added to the addendum  $S$ , the corrected figures to use being found in column  $s''$ .

For any other pitch, divide figures in table by the required pitch.

No. of Teeth	t"	s"	No. of Teeth	t"	s"	No. of Teeth	t"	s"
6	1.5529	1.1022	51	1.5706	1.0121	96	1.5707	1.0064
7	1.5568	1.0873	52	1.5706	1.0119	97	1.5707	1.0064
8	1.5607	1.0769	53	1.5706	1.0117	98	1.5707	1.0063
9	1.5628	1.0684	54	1.5706	1.0114	99	1.5707	1.0062
10	1.5643	1.0616	55	1.5706	1.0112	100	1.5707	1.0061
11	1.5654	1.0559	56	1.5706	1.0110	101	1.5707	1.0061
12	1.5663	1.0514	57	1.5706	1.0108	102	1.5707	1.0060
13	1.5670	1.0474	58	1.5706	1.0106	103	1.5707	1.0060
14	1.5675	1.0440	59	1.5706	1.0105	104	1.5707	1.0059
15	1.5679	1.0411	60	1.5706	1.0102	105	1.5707	1.0059
16	1.5683	1.0385	61	1.5706	1.0101	106	1.5707	1.0058
17	1.5686	1.0362	62	1.5706	1.0100	107	1.5707	1.0058
18	1.5688	1.0342	63	1.5706	1.0098	108	1.5707	1.0057
19	1.5690	1.0324	64	1.5706	1.0097	109	1.5707	1.0057
20	1.5692	1.0308	65	1.5706	1.0095	110	1.5707	1.0056
21	1.5694	1.0294	66	1.5706	1.0094	111	1.5707	1.0056
22	1.5695	1.0281	67	1.5706	1.0092	112	1.5707	1.0055
23	1.5696	1.0268	68	1.5706	1.0091	113	1.5707	1.0055
24	1.5697	1.0257	69	1.5707	1.0090	114	1.5707	1.0054
25	1.5698	1.0247	70	1.5707	1.0088	115	1.5707	1.0054
26	1.5698	1.0237	71	1.5707	1.0087	116	1.5707	1.0053
27	1.5699	1.0228	72	1.5707	1.0086	117	1.5707	1.0053
28	1.5700	1.0220	73	1.5707	1.0085	118	1.5707	1.0053
29	1.5700	1.0213	74	1.5707	1.0084	119	1.5707	1.0052
30	1.5701	1.0208	75	1.5707	1.0083	120	1.5707	1.0052
31	1.5701	1.0199	76	1.5707	1.0081	121	1.5707	1.0051
32	1.5702	1.0193	77	1.5707	1.0080	122	1.5707	1.0051
33	1.5702	1.0187	78	1.5707	1.0079	123	1.5707	1.0050
34	1.5702	1.0181	79	1.5707	1.0078	124	1.5707	1.0050
35	1.5702	1.0176	80	1.5707	1.0077	125	1.5707	1.0049
36	1.5703	1.0171	81	1.5707	1.0076	126	1.5707	1.0049
37	1.5703	1.0167	82	1.5707	1.0075	127	1.5707	1.0049
38	1.5703	1.0162	83	1.5707	1.0074	128	1.5707	1.0048
39	1.5704	1.0158	84	1.5707	1.0074	129	1.5707	1.0048
40	1.5704	1.0154	85	1.5707	1.0073	130	1.5707	1.0047
41	1.5704	1.0150	86	1.5707	1.0072	131	1.5708	1.0047
42	1.5704	1.0147	87	1.5707	1.0071	132	1.5708	1.0047
43	1.5705	1.0143	88	1.5707	1.0070	133	1.5708	1.0047
44	1.5705	1.0140	89	1.5707	1.0069	134	1.5708	1.0046
45	1.5705	1.0137	90	1.5707	1.0068	135	1.5708	1.0046
46	1.5705	1.0134	91	1.5707	1.0068	150	1.5708	1.0045
47	1.5705	1.0131	92	1.5707	1.0067	250	1.5708	1.0025
48	1.5705	1.0129	93	1.5707	1.0067	Rack	1.5708	1.0000
49	1.5705	1.0126	94	1.5707	1.0066			
50	1.5705	1.0123	95	1.5707	1.0065			

## Vernier Height Gages

Like the Vernier caliper, the Vernier height gage consists of a stationary bar or beam and a movable slide. The graduated, hardened and ground beam is combined with a hardened, ground and lapped base. The slide Vernier assembly can be raised or lowered to any position along the bar and adjusted in thousandths of an inch by means of the Vernier slide fine adjusting knob.

Set up as shown right with hardened steel scriber clamped to the Vernier slide, the Vernier height gage is used on a surface plate or machine table to mark off vertical distances and locate center distances. Other accessories include depth attachments, tungsten-carbide scribers, offset scribers, test indicators, electronic transducers and attachments that allow use with many dial indicators.

Beam and Vernier plate graduations are identical with the outside scale of the Vernier caliper and readings as described on pages 31, 32 and 33.



Last Word® dial test indicator attached to Vernier height gage for comparing measurements from gage blocks with the work. Shown with the PT99441 attachment that allows using many dial indicators.

**Starrett 254 Series  
Master Vernier  
Height Gage.**

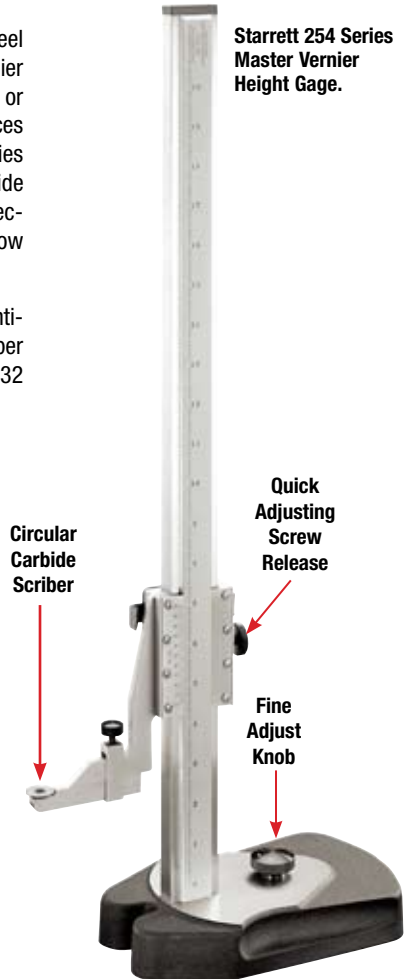

## Electronic & Dial Height Gages



**Altissimo  
Platinum  
Height Gage.**

**No. 2001 Altissimo "Platinum" Height Gage** is our most sophisticated electronic height gage with many Starrett-exclusive functions and features. It has a unique, hardened and ground ergonomically shaped base that fits your grip to easily move. The "Hot Key" lets you select measuring results on the fly and its smart probe that can measure I.D. or O.D. without attachments. It includes RS232 output.

**The 3752 Electronic Height Gage** is a versatile height gage featuring a large easy-to-read LCD display and intuitive control panel. It has clear bar graduations, and a full range of features not often available in a mid-range electronic height gage. It is available with 0-12" and 0-24" models. It also includes RS232 output.

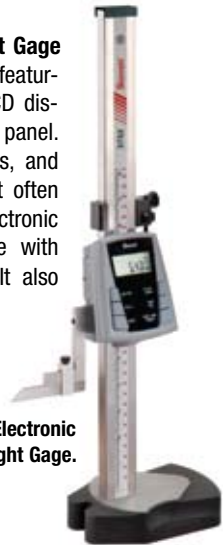

**3752 Electronic  
Height Gage.**

### The 3751A Electronic Height Gage

is an economical, light, portable and easy to use entry-level gage with a full range features such as inch/metric conversion, zero at any position, auto off after five minutes and the durable, well designed mechanical attributes characteristic of a Starrett tool.



**3751AZ-  
6/150 Electronic  
Height Gage**

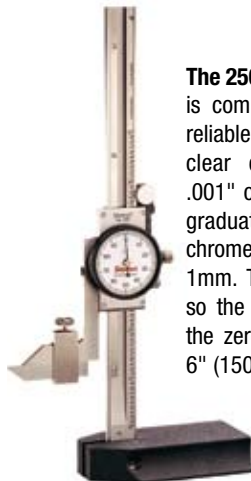

**The 250-6 Dial Height Gage** is compact, simple to use, reliable and accurate. It has clear dial graduations of .001" or 0.02mm and sharp graduations on the satin chrome bar every .100" or 1mm. The base is designed so the gage can read from the zero position to the full 6" (150mm) range.

**250-6 Dial  
Height Gage**



## Depth Gages

Depth Gages are an adaptation of the rule or Vernier scale for measuring the depth of holes, recesses, etc. They include a sliding stock or base set at right angles to the rule and with a means of clamping the slide to lock the reading. Another gage is a combination depth and angle gage. An optional hook on the rule is available to measure from an undercut or recess.



Vernier  
Depth  
Gage



Rule  
Depth  
Gage



Combination  
Depth and  
Angle Gage  
with Hook

Checking the depth of a blind hole with a depth gage.



## Electronic Depth Gage

The 3753 Electronic Depth Gage provides easy, accurate depth measurements of holes, slots and recesses. The 753 has a range of up to 0-12" (0-300mm); linear accuracy of  $\pm .001"$  ( $\pm 0.03\text{mm}$ ) and resolution of  $.0005"$  (0.01mm) with output to SPC peripherals.

## Dial Depth Gage

A dial depth gage in either a 6" or 12" (150mm or 300mm) range is a quick and accurate method of measuring depth of holes, slots and recesses. Readings are taken directly from the rack



and the dial indicator. Large openings can be measured using a 7" or 12" extension base, which can also be positioned to the right or left for off-center slots, close to shoulders and between obstructions. The removable hook permits readings from the edge of a workpiece to edges of slots, shoulders, etc.

## Surface Preparation

**Preparing the Surface** For rough surfaced work such as castings or for work where little accuracy is required, rubbing chalk upon the surface of the work will serve as a coating to make scribed lines more visible. For fine, exact layouts, on smooth or finished surfaces, a special marking solution should be used.

Products such as Starrett Layout Dye, can be applied to any metallic surface and will take clean, sharp scribed lines without chipping or peeling. For best results, the surface should be free of grease, oil, cutting solution, etc., before the dye is applied.



Blue layout dye being applied by brush.



Blue layout dye in spray can.

---

## Laying Out and Scribing Lines



For precise layout of three identical circles, this mechanic uses 6" spring dividers.

Layout and scribing include the placing of lines, circles, centers, etc. upon the surface of any material, for shaping the finished workpiece.

These basics include the proper selection and use of scribes, dividers, scratch gages, tram-mels, surface gages, straight edges, squares and protractors. It is very important that the points of these tools be kept sharp and free of burrs to accurately locate centers, radii, edges and intersecting points.

Fine and accurate layouts grow in value, as the need for better jigs, fixtures, tools and production machines increases.

To produce deep or shallow dimple using a center punch requires practice. However, automatic center punches, which contain a built-in adjustable hammer, assist the craftsman by freeing up both hand and eye, to steady the workpiece and keep eye contact at the point of contact.



Scribing lines with a Starrett Auxiliary Scriber.

## Work Location

Many types of tools are available for locating work in machining, layout, checking or inspection operations, either on surface plates, angle plates, or in various types of chucks and work-holding devices on machine tools. These include test indicators, center finders, V blocks, edge finders and other devices.

Work surfaces may be located easily, quickly and accurately with the edge finder. The edge finder is placed in the machine collet or the chuck. The work table is then traversed to obtain contact between rotating edge finder and work. Contact will shift to a concentric position relative to the body and with very slight additional table adjustment will move off center with a decided wobble. At this point, the center of the finder is exactly one-half the diameter of the contact from the work edge permitting accurate location for other machining operations relative to the edge.

To locate center points and scribed lines, put a rule or pencil tip along a scribed line. Then, carefully bring the edge finder's pointed contact to the center point or intersection of scribed lines and adjust the table so that it barely touches the work.



Starrett 827B Edge Finder with double end.

Locating work from straight edge using a single end edge finder mounted in chuck of machine tool.

Starrett V Blocks and Clamps.

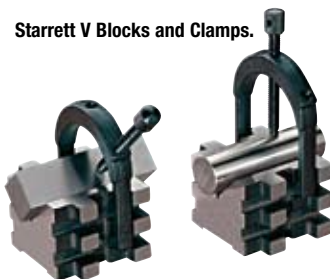

## Measuring Lathe Work

Work done on the lathes is of such variety that a considerable list of measuring tools could be needed to cover all cases. Ordinarily, the principle measurements are concerned with centering the work in the lathe, measuring length and measuring diameters.

### Centering the Work



For efficient turning with a minimum of waste, and without excessive vibration, it is useful to locate the center of work. When the work is turned from ordinary cylindrical bar stock, this can be done using the center head attachment and the blade of a combination square. Scribe center lines on the end of the piece, shifting the tool about 90 degrees between lines to arrive at a common center.

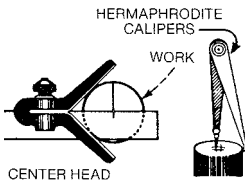

A hermaprodite caliper may also be used with the legs opened to approximately half the diameter of the piece. Three or four arcs scribed from various points on the circumference will narrow down the location so that the true center can be estimated with considerable accuracy. The centers as determined by either method described should be set with a center punch then tested by spinning the piece in a lathe on centers to check concentricity before drilling and countersinking the center holes.

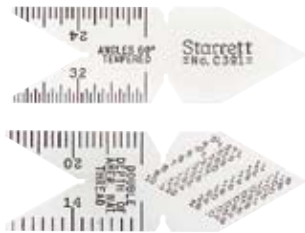

Shown No. C391 Center Gage.

Where there is reason to suspect distortion or variation in diameter of the work such as in castings or forgings, it is good practice to use a height or surface gage and a surface plate to determine the centers. Lines scribed on the ends with reference to various points on the circumference will locate the center with provision for an average of surface errors and insure a reasonable balance while turning the casting or forging to uniform diameter. Work so distorted as to teeter on the surface plate should be placed upon parallels or straight edges.

Center holes are countersunk to match the 60° included angle of the lathe centers. It is good practice to check the angle of the live and dead center points from time to time to make sure that they have not become worn or distorted. This is done with a center gage, a little tool that is also useful in grinding and setting thread cutting tools.

## Ground Flat Stock

Since much layout work is concerned with the preparation of templates, gages, test and cutting tools, machine parts, jig and fixture parts, etc., there are many advantages to Ground Flat Stock. This is high grade tool steel available in 18, 24 and 36 inch lengths in a variety of widths and thicknesses. It is accurately ground to within .001 inch in thickness and annealed for easy machining. Starrett Ground Flat Stock is available in three types: oil hardening, air hardening and low carbon.

### Ground Flat Stock Selection

Starrett No. 496 Oil Hardening flat stock and die stock is made of dimensionally stable chromium, tungsten, vanadium electric tool steel to rigid Starrett specifications in 18 and 36 inch lengths. Ideal for all intricate work and work with thin sections.

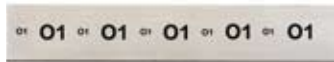

497 Air Hardening flat stock and die stock is made to a special analysis for hardening in air. The dimensionally stable characteristics closely maintain accuracy of dimension, eliminating distortion and cracking, thus the cost of grinding to final size is substantially reduced. It is available in 18 and 36 inch lengths.

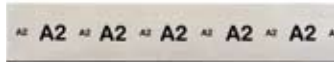

No. 498 Low Carbon is a highly machinable and economically priced alloy that can be used in various applications. Starrett's Low Carbon is a .20 Carbon, fine-grained, killed steel that can be carburized or case hardened. It provides longer cutting tool life with lower machining costs, better finish and faster production. Due to the tight control of the Sulfur content, Starrett Low Carbon is easily welded. It is available in 24" lengths.



Parts made from Starrett Precision Ground Flat Stock.

## Measurements of Length and Diameter

Measurements of length and diameters are performed with steel rules, calipers and dividers, micrometers, Vernier calipers, dial indicator gages, etc., according to the nature of the work and the degree of precision required. In addition, the lathe operators can make considerable use of surface gages, test indicators, telescoping gages, and inside micrometers.

The surface gage is useful for scribing lines around cylindrical work or for scribing concentric circles on the face of work held in a chuck. Test indicators are especially valuable for truing work in a lathe chuck since they can be used for checking internal and external concentricity as well as surface alignment.



For a quick check of runout, lathe operator uses universal dial test indicator mounted in tool post.



Checking lathework with dial test indicator. Tool post holder holds indicator securely in position.



Checking inside diameter of a deep hole with an inside micrometer. Convenient handle is attached to the center of the micrometer.

## Measuring Screw Threads

To determine the number of threads per inch (TPI), the pitch of a few bolts, nuts, threaded holes or studs, simple measuring devices can be used. For example, when a count of threads per inch is desired, an ordinary steel rule can suffice. Simply line up the one inch line graduation of a steel rule with the crest (point) of a thread (see diagram 1) and count the number of crests (points) over that one inch thread length. If that number is twelve over a one inch thread length, then the number of threads per inch is twelve. If the overall thread length is shorter than an inch, count the crests over only a half inch, then multiply the number by two.



Diagram 1

For example, if you counted six threads over a half inch, then  $6 \times 2 = 12$ . There are twelve threads per inch. If you counted five threads over a quarter inch, then there are twenty threads per inch, and so on.

**Screw Pitch Gage** Screw pitch and TPI can be determined readily with a screw pitch gage (see diagram 2) which is a set of thin steel leaves. The individual leaf edges have "teeth" corresponding to a fixed thread pitch.



Shown  
No. 473.

Diagram 2  
Screw pitch gage measures 30 pitches –  
V, Unified, American National 60° threads.

The leaves on Starrett screw pitch gages are stamped to show the thread pitch number to easily determine the thread pitch and TPI by matching the correct leaf fit with threads on your part.

Major (crest) and minor (root) diameters of threaded parts can vary depending upon the sharpness or fullness (truncations) of the thread. Measurements are usually made at the pitch line to determine the pitch diameter. Therefore, pitch diameter is the diameter of a cylinder passing through the thread profile, so as to make the widths of thread ridges and widths of thread grooves equal.

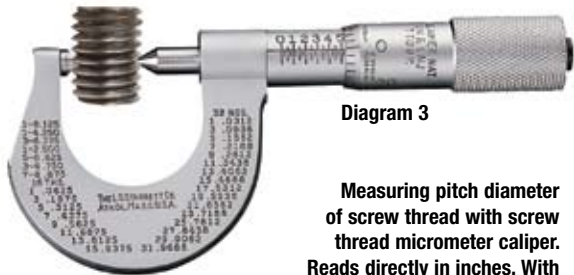

Diagram 3

Measuring pitch diameter of screw thread with screw thread micrometer caliper. Reads directly in inches. With anvil and spindle in position shown in sketch, line A-B corresponds to 0 reading.



## Measuring Screw Threads (Continued)

Screw thread micrometers (see diagram 3) with a pointed spindle and V-shaped anvil are used to measure pitch diameters. The point of the spindle and the V-shaped anvil (see diagram 3A) are designed so that contact is made on the side (flank) of the thread.

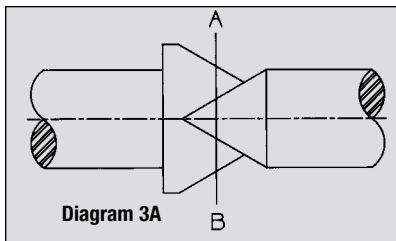

## Telescoping Gages

**Telescoping Gages** are sometimes better than leg calipers for measuring internal diameters. The head of a telescoping gage expands across the hole, is locked and then measured with a micrometer. Or, the gage can be set to a standard and used to make shrink, close, or loose fits. Handles up to 12 inches are available.

**Accurate measurements are ensured with telescoping gage. Handle is automatically self-centering. Shown, No. 579.**



**Small Hole Gages** serve the same purpose for holes ranging from 1/8 to 1/2 inch. They are made with a split ball at the contact end which is expanded to get the measurement which is then transferred to a micrometer, duplicating as close as possible the "feel" of the gage in the hole.

**Ball contacts with flat ends allow shallow slots and recesses to be measured. Shown No. 830.**



**Radius Gages** are useful for machining, inspection and layout. They come in radii from 1/64" to 1/2", decimal sizes .010" to .500" and 0.5mm to 15mm, metric. Each gage has five different gaging surfaces for both convex and concave radii. A gage holder is available for checking radii in hard-to-reach locations.

**Radius Gage in holder provides fast check of 1/4" radii milled on this work piece. Shown No. 167 with a No. 110 holder.**





## Measuring Angles

**Protractors:** Measuring the angular relationship of two or more lines or surfaces can be performed with a variety of tools depending upon the degree of precision required and the job in hand. For simple angles, a common protractor will serve, with a half circle ( $180^\circ$ ) graduated in degrees so that angles can be measured or laid out. The rectangular shape has the advantage that any one of four edges can be used as a vertical or horizontal line of reference.



Starrett No. C493B Protractor measures angles from 0 to 180 degrees and also can be used as depth gage.

**Bevels:** For comparing or checking angles, a bevel serves the same purpose as a steel square for rectangles. It consists of a stock and pivoted blade joined by a locking screw. The bevel can be set to a protractor and used as a gage when turning angles on a lathe or the stock and blade can be locked to transfer any angle from the work to a protractor. The addition of an auxiliary blade results in a combination bevel, a more versatile and adaptable tool.

**Bevel Protractors:** A protractor and bevel are combined for greater convenience in the universal bevel protractor. It consists of a graduated disk with a fixed blade and an adjustable stock. With this tool, any angle may be laid out or measured by reading the angle of stock and blades as shown on the protractor scale in degrees. By means of a Vernier and ultra-fine adjustment, it is possible to accurately read angles to 5 minutes or  $1/12$  of a degree. Extremely close angular measurements to accuracies as close as  $1/4$  second can be accomplished by means of angle gage blocks.

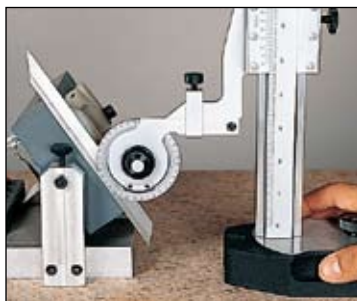

Checking angle with universal bevel protractor mounted on Vernier height gage No. 254.

## Gages for a Variety of Measuring Needs

**Drill Point Gages:** Accurate holes can be drilled only when drill points are ground accurately. When properly sharpened each lip of a drill is the same length and has the same angle in relation to the axis of the drill. The Starrett 22C Drill Point Gage can check lip angle and length of all drills not sharpened with a precision grinding machine. The gage consists of a blade and sliding head with the head set at the correct angle of 59° and graduated to compare lip lengths to within 1/64 inch.

**Starrett No. 22C drill-point gage checks both drill point angle and lip length, ensuring properly sharpened drills.**



**Thickness Gages:** Thickness or feeler gages have from six up to thirty-one leaves ranging from .0015 to .200" thick. They are mainly used by tool and die makers, machinists, screw machine operators, pattern makers and in other related fields to lay out and check clearance, gap, parallelism, etc., and are also used for tasks such as setting spark plug gaps. Thickness gages are available in metric with straight or tapered leaves in varying lengths and wire type for automotive use.



**No. 66 Thickness Gage has 26 leaves from .0015 to .025 inch thick.**



**Thickness Gage Stock:** Thickness gage or feeler stock is available in rolls in a rewind dispenser case. Twenty-seven inch thicknesses (.001" to .025"), eleven metric thicknesses (.03 to .35mm) are available in a rewind case. Three metric thicknesses (.40mm, .45mm and .50mm) are offered in a cardboard box. Twelve-inch lengths also available, in sizes from .001 to .303" and metric sizes .03mm to .5mm.

**No. 666 Thickness Gage/Feeler Stock in a rewind dispenser case.**

Many other gages are available, including a fillet or radius gage to check radii of tools and ball and diameter gages to check roughing and finishing cutters.

**178 Radius Gage**

**710 Ball and Diameter Gage**

**466 Angle Gage**

## Dial Indicators

One of the most widely used tools today in layout, inspection and quality control operations is the dial indicator. Specially designed with shockless hardened stainless steel gear train and manufactured to fine watchmaking standards with jeweled bearings, the dial indicator has precisely finished gears, pinions and other working parts that make possible measurements from one-thousandth to 50 millionths of an inch, depending on accuracy requirements. Any gear unit and any case assembly can be combined to give a complete dial indicator of the style desired. Dial faces are color coded to avoid errors, white dial for English measurement and yellow face for metric.

The contact point is attached to a spindle or rack with movement transmitted to a pinion and then through a train of gears to a hand which sweeps the dial of the indicator. A small movement of the contact is thus greatly magnified and read directly from the dial in thousandths or as close as 50 millionths of an inch. Long range indicators have direct reading count hands and a double dial. Graduations are available for reading in .001", .0005", .00025", .0001" and .00005" – with ranges from 12" down to .006"; also in .01mm, .002mm, and .001mm with ranges up to 125mm. Dials can have balanced or continuous graduations.



**Typical Starrett Dial Indicators in the four standard American gage design sizes.**

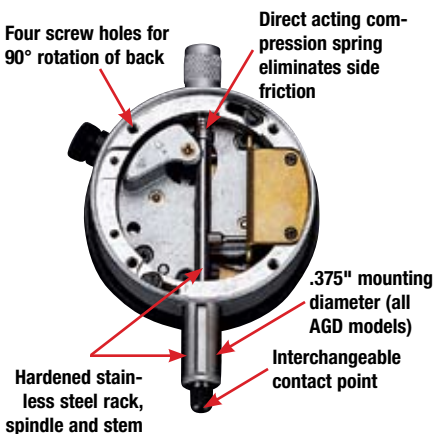

When a dial indicator is subject to sudden blows or shock, a NONSHOCK mechanism can be substituted for the regular mechanism. Impact and shock are completely absorbed and isolated from the gear movement. Any regular dial indicator can also be converted into nonshock type by replacing the regular contact points with a shock absorbing anvil unit. The regular contact point may be replaced with contacts of almost any shape or length to suit the work. These include contact points of extra length, special form, tapered, and a roller contact for use on moving material. Many useful attachments are available to suit work requirements. Dial indicators

can be furnished with tolerance hands, with special dials, with rubber dust guards to seal out dust and foreign matter; with anti-magnetic mechanisms when the dial indicator is used near magnetic fields, with long stems up to 12 inches for use in deep holes; with lever control for lifting the indicator spindle.

Super-precision dial indicators with graduations in 50 millionths (.00005) of an inch and accuracy to plus or minus 10 millionths ( $\pm .00001$ ) are also available. These are used for applications requiring extreme precision such as in shop inspection to laboratory standards or in laboratory work. The long range dial indicator with ranges of 2, 3, 4, or 5 inches and on up to 12 inches (and comparable metric ranges through 125mm) makes possible all types of long range gaging such as on jig and fixture work, for production measuring on machine tools or as precision stops. Count hands and double dials permit direct reading in thousandths of an inch.

**Magnetic Backs:** Magnetic backs provide a quick and easy means of attaching any Starrett dial indicator to flat ferrous metal surfaces. A real time saver for machine, jig and fixture setup.

**Dial Gages:** The principle of direct reading from a pointer and graduated dial provides both the accuracy and the speed of reading essential in many of today's inspection operations, and consequently, the dial indicator has been incorporated in all types of special and standard gaging equipment, as well as in many machine tools. Some gages are direct reading and others serve as comparators showing plus or minus variations in size.



Starrett No. 676-2  
Magnetic Back.

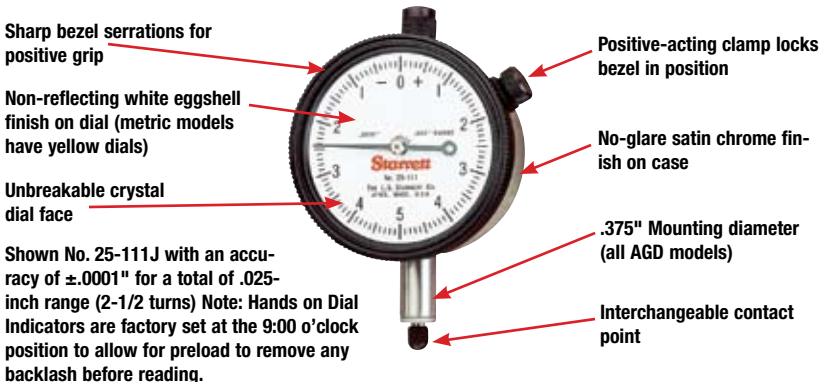

Sharp bezel serrations for positive grip

Non-reflecting white eggshell finish on dial (metric models have yellow dials)

Unbreakable crystal dial face

Shown No. 25-111J with an accuracy of  $\pm .0001$ " for a total of .025-inch range (2-1/2 turns) Note: Hands on Dial Indicators are factory set at the 9:00 o'clock position to allow for preload to remove any backlash before reading.

Positive-acting clamp locks bezel in position

No-glare satin chrome finish on case

.375" Mounting diameter (all AGD models)

Interchangeable contact point

## Electronic Indicators

Electronic indicators offer the advantages of an easy-to-read LCD display with some models also offering inch/metric conversion and SPC output.

**3600 Series Electronic Indicators** have simple, powerful, easy-to-use functions and are available in inch/metric and metric only versions. They have a large LCD display, range of .500" (12.7mm) and resolution of .0005" (.01mm).

**2600 Wisdom® Series Electronic Indicators** have a 1" (25mm) range, readout to .0005" and 0.01mm. Basic models have inch/mm conversion, zero at any position, plus/minus control and automatic off after one hour of nonuse. Full function models have in addition, shift buttons, min/max modes, limits mode and RS232 output.

More advanced, the **2700 Wisdom® Series** has all of the features of the 2600 Series, plus a 4" and a 100mm range and user selectable resolutions.

**3600 Series  
Electronic  
Indicator.**



**F2730-0 Wisdom®  
Electronic Indicator**



**2600-4 Electronic  
Indicator with a  
DataSure Endnode**

## Dial Comparator

The dial comparator is used for inspecting duplicate parts and various materials, either in bench inspection or on the production line. The precision ground base accommodates all types of work as well as V blocks and fixtures. A dial indicator with fine setting adjustment is mounted on an adjustable bracket on a vertical post. A hand lever operates the indicator to contact the work and size variations are read from the dial. This unit is available mounted on a granite base.

**653J Dial Bench  
Comparator.**



## Dial Test Indicators

The dial test indicator is an all purpose tool used in layout, inspection and on machine tools for truing up work, checking runout, concentricity, straightness, surface alignment, and for transferring measurements. They work with various attachments, including a tool post holder, adapt it to a wide range of applications, such as checking runout of a spindle turned on a lathe.

**Dovetail Mount Indicators** such as the Starrett 708 and 709 Series' Precision Dial Test Indicators with dovetail mounts can be positioned for easy and accurate readability. The versatility of the angled head, combined with the three dovetail mounts eliminates the need for having both vertical and horizontal style test indicators and work with existing test indicator accessories available with English and metric dials.



708AZ Dial Indicator.

709MAZ angled head for easy reading.



709B Dial Test Indicator attached to a 660 Magnetic Base Indicator Holder in an application to check for roundness.

---

## Magnetic Base Holders

A magnetic base indicator holder greatly increases the usefulness and application of the dial indicator on all shop setup, checking and inspection jobs. The time spent clamping an indicator to a machine is eliminated since its powerful, permanent magnet base holds to any flat or round steel or iron surface – horizontally, vertically, upside down or on shafts using a precision ground “V” on one face.

A push button or lever turns the magnetic force on or off. They work with a variety of indicators and holding arrangements to suit the work.

The Starrett FLEX-O-POST indicator holder provides complete flexibility so indicators can reach awkward, hard-to-reach positions that can not be accessed with conventional indicator holding devices.



631 Back Plunger Dial Indicator attached to No. 657-1 Magnetic Base Universal Indicator Holder.

## Dial Bore Gages

Dial bore gages are used for precision measuring of cylindrical bores. They quickly inspect hole diameters and will detect and measure any variation from a true bore, such as taper, out-of-roundness, bellmouth, hourglass or barrel shapes. Basically, the gage consists of a contact head, an indicator housing and handle. An adjustable range screw plus two centralizing plungers give the gage 3-point contact to insure true alignment. The gaging contact actuates a dial indicator for comparative readings in half-thousandths (.0005") or ten-thousandths (.0001").



Models are available with ranges from 1-1/2-12-1/8" diameter and 6-7" bore depths. For smaller diameters, a series of split-ball type bore gages are available that will measure holes ranging from .107-1.565" diameters and 13/16-5" bore depths in .0001" increments.

**Bore measurement with a 84 Series Dial Bore Gage.**

## Dial Indicator Internal Groove Gages

A fast, accurate way to measure the inside diameter of grooves of all types is by means of the dial indicator internal groove gage. The gage has adjustments to handle a range of diameters from .375-6" and eliminates the need for expensive gages for every job. Special extensions for additional in-reach and range are also available. The upper sensitive jaw is retracted by a thumb lever through a parallel motion transfer system, permitting insertion of the gage into the work. Maximum inreach is 6".

A comparison reading of the work variations is transferred through a motion-transfer mechanism to a dial indicator reading in .0005". The gage is preset to a known master.



**1175 Dial Indicator Groove Gage.**

## Dial Indicator Diameter Gages

When many large diameters (up to 60") need to be measured, a dial indicator diameter gage can be used. They are adaptable to a wide range of applications such as measuring internal and external shallow diameters, roundness, concentricity, grooves, recesses, shoulders and tapers. Nine gage sizes are available for diameters from 1 - 60".



**1101-M18 Dial Indicator Diameter Gage.**



## Chamfer, Countersink & Hole Gages

These gages provide fast, accurate, easy-to-read measurements with one hand operation. A check gage stand is also available.

**Chamfer Gages** measure any chamfered hole that has an included angle equal to or less than the angle on the dial face. They are available in 0°- 90° and 90°-127° angles in both I.D. and O.D. models with a range of 0-3/8" and 1-2". These gages need no setting master.

**Countersink Gages** directly read countersinks and chamfers in .002" diameter increments. This series of gages comes in 80°, 90° and 100° angles in a range of .020-.078". A "set master" ring is included with each gage. Indicator reading is "held" until the reset button is activated, giving you added control.

**Hole Gages** will check hole diameters to .001" English and .02mm Metric. The English range is .010-.330". Metric range is .25mm-8.35mm. An optional "set master" ring is available. Metric dial faces are yellow.

683-1Z  
Chamfer  
Gage 0°-90°  
I.D. Angle  
0"-1" Range.



688-3Z  
Countersink  
Gage 90° Angle  
.360"-.560"  
Range.

690-3Z Hole  
Gage, Inch  
Reading  
.230"-.330"  
Range.

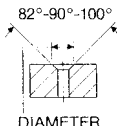
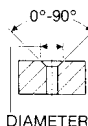

## Dial Indicator Snap Gages

This snap gage also uses a dial indicator for reading the variation in diameter in tenths of a thousandth (.0001) of an inch. The gage has a light, rigid "C" frame with insulating handle and two adjustable gaging contacts, and an adjustable backstop to set throat depth. The upper sensitive contact transfers work dimension through a motion transfer mechanism to a dial indicator. The gage is preset to a known master.

The snap gage can be used hand-held, with a stand as a bench comparator, or with an electronic probe (No. 715-2Z) and electronic (No. 717) amplifier in place of the standard dial indicator. This unit is completely portable.



1150-2 Dial Indicator Snap Gage.



## Gage Amplifiers



The 776 accepts multiple gage inputs simultaneously – invaluable for applications such as this Starrett special gage fixture.



**No. 717 Electronic Gage Amplifier:** Electronic gaging is easier with the 717 Electronic Gage Amplifier. With both analog and digital output, the 717 offers flexibility in data presentation while providing the best approach to comparative, dynamic and differential precision measuring. It has accuracy within  $\pm 2\%$  of full scale. Has dual inputs for cumulative/differential measurements, selectable inch or millimeter ranges, selectable digital or analog output, and simple “push-button” calibration.

**No. 776 Series Gage-Check Multi-Axis Measured Value Display** accepts up to eight inputs. It features intuitive visual display, helpful audio cues and user-defined formulas. Gage-Check also reports dynamic Min/Max measurements, provides SPC analysis from integrated database, and includes connectivity to PCs and other Starrett tools. A large 6" color flat-panel LCD screen has an adjustable tilt base. Supports 1, 4, or 8 input channels. These can be mathematically combined to display dimensions such as flatness, volume or runout. Screens include individual readings that can display four lines simultaneously, bar and dial position style displays, graphs and histograms of measurement statistics and tables of measurements and SPC data.



**No. 717 Starrett Electronic Gage Amplifier with Nos. 252 Transfer Gage and 715-1Z Gaging Head.**

## Special Gages

If your application has measuring requirements that are beyond the capabilities of standard products due to special standards, shape, size, etc., the Starrett Special Gage Division is available to work with your company to design and build custom tooling to meet your needs.

Samples of some of our past work is shown below.



## Granite Surface Plates

Every linear measurement depends on an accurate reference surface from which final dimensions are taken. Starrett Precision Granite Surface Plates provide this reference plane for work inspection and for work layout prior to machining. Their high degree of flatness, overall quality and workmanship also make them ideal bases for mounting sophisticated mechanical, electronic and optical gaging systems.

**Material:** The most important element in the performance and life of granite surface plates is the percentage of quartz that is present in the stone. Quartz is more than twice as resistant to wear as the other minerals in granite. It provides bearing points that are of a hard, highly polished, smooth character which protect the accuracy and finish of both the surface plate and the tools and instruments used on it.

Starrett Crystal Pink® Granite has the highest percentage of quartz of any granite. Our Charcoal Black Granite also contains quartz, though a slightly lower content than our Crystal Pink, but higher than other plates produced with black granite. Higher quartz content means greater wear resistance. The longer a surface plate holds its accuracy, the less often it will require resurfacing.

**Ledges and Clamping:** Surface plates without work clamping ledges are recommended for sustained accuracy and reliability. Ledges are for work clamping purposes only. If excessive torque is used when applying clamps to ledges, it can adversely affect measurements taken near the plate edges. If clamping is important, T-slots and threaded metal inserts may be installed in the surface.



**Special Plates** are usually requested in two different categories: the first category is for inspecting oversize parts and assemblies such as diesel engine blocks and crankshafts, vehicle frames, missile components and ground support equipment; the second category relates to modifying standard plates or building special plates for work-holding attachments of many types. Threaded inserts, studs, adaptor holes, T-slots, dovetails – almost anything can also be added to Starrett Tru-Stone Surface Plates extending their accuracy and versatility for numerous applications.

## Data Collection

The DataSure® Wireless Data Collection System is a robust system that increases throughput and eliminates recording errors for applications where measurement data is collected.

It reaches anywhere measurements are taken with electronic metrology tools – shopfloors, labs, quality assurance departments – they can all benefit from the capabilities of DataSure Wireless Data Collection System. Cost-effective for bench-top or shop-wide data collection, DataSure systems can cover thousands of square feet while reliably protecting the integrity of the vital measurement data being collected.



### What is Wireless Data Collection?

Wireless data collection systems consist of three primary elements: miniature radios (called End Nodes) that are attached to the data output ports of electronic tools, a Gateway that connects to a PC, and Routers that extend the system's range and make the radio network more robust.

DataSure gathers data from electronic measuring tools and delivers it to a PC. The data can then be analyzed by your statistical process control (SPC) application.

### Why Go Wireless?

A wireless data collection system can significantly reduce human error in data recording. It removes wiring-related placement, installation, safety and cost issues. It also makes it easier for you to bring a precision measuring tool to the work, rather than having to bring work to the measuring tool.

### A Comprehensive, Robust Solution

- The safe delivery of your data is ensured even in the hostile environment of electrically noisy shops, thanks to proprietary Starrett technology.
- Each measurement is time-stamped and logged into a database. DataSure sends a signal to ensure that data is received at the PC.



Data collection tools with DataSure® End Nodes.

- If receipt is not acknowledged at the host SPC system, DataSure will store up to 10 readings and resend them until they are safely recorded. With DataSure, there's no need to worry about losing an entire shift's worth of collected data.
- DataSure adapts to all major brands of electronic measuring tools, and a variety of software and tools, so you don't have to invest in proprietary technology.
- It installs easily on a PC with required Windows® XP Professional and works with most SPC software packages.
- DataSure's versatility means it will work in almost any environment. Its highly configurable system architecture adapts to your work environment. Each DataSure system supports up to 80 tools, and can be remotely accessed via your intranet connection.

## SPC Software for Data Collection

**Starrett 739 SPC Plus® II Software** is an advanced Windows® based program that is fast, versatile and easy to use for quality control and SPC/QC applications. Data can be entered from any electronic measuring tool with output. The software allows data manipulation for analysis and dynamic data exchange for real time data input.



- Read directly from Excel Files to immediately begin to analyze with control charts.
- A variety of gages can be used to add data to the spreadsheet using our Real-Time Gage.
- Data is entered directly into SPC-PLUS II's spreadsheet which has many functions for calculating user-defined parameters.

**Shop Floor Pro™ Software** provides powerful data acquisition and analysis features in an intuitive, simple-to-use interface.

- Easy to learn real-time data collection and control charting software package.
- Operates in a stand-alone or networked environment.
- Allows for data entry directly from gages or through the keyboard.
- Pre-defined Work Sets can be created for Work Centers, part numbers, etc. Each Work Set opens in a single step and supports up to 20 control charts.
- Control charts can show different characteristics for the same part or characteristics from multiple parts.
- Chart Types include X-Bar/Range, X-Bar Sigma, Individual-X/Moving Range and Run Charts. User definable subgroup sizes range from 1-20.

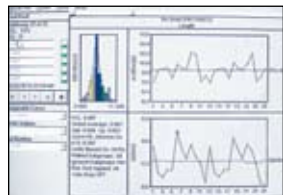

## Gage Blocks



**Starrett-Webber Gage Blocks are available in high-grade steel, ceramic, and croblox® (chromium carbide).**

The international standards of length (the meter and International Inch) are established in terms of light waves using the definition of the speed of light and atomic clocks.

Light waves, of course, cannot be handled like a micrometer or Vernier caliper, but they are used to establish the length of physical standards having accuracies in millionths of an inch (.000001"). These standards are called gage blocks.

Precision gage blocks are the primary standards vital to dimensional quality control in the manufacture of interchangeable parts. These blocks are used for calibrating precision measuring tools and for setting numerous comparative type gages used in incoming, production and final inspection areas. Gage blocks provide the most economical, accurate method of setting dial test indicators and electronic gages used in conjunction with surface plates for inspecting parts with exacting

tolerances. Essentially, they consist of blocks of a hard stable material with a flat, parallel gaging surface on each end. The measuring surfaces are ground and lapped to an overall dimension with a tolerance of plus or minus a few millionths of an inch. Gage blocks may be stacked or "wrung" together to form accurate standards of practically any length.

Gage blocks are made in several grades or degrees of accuracy. Grade 0 is the most popular grade of gage blocks as this grade is usually suitable for most applications, and is a grade that offers the best combination of accuracy and cost. The higher accuracy grades of blocks such as Grade 00 and Webber Laboratory Grade (LM) are primarily used as masters to check other gage blocks and for applications that require extreme accuracy. Grade B ( $\pm 50$  microinches) blocks are very inexpensive but are limited to workshop use where exacting accuracy is not required.





## Gage Blocks (Continued)

Gage blocks are available in various materials. Webber croblox<sup>®</sup>, the world's finest gage blocks, are made of chrome carbide which is longwearing, dimensionally stable and extremely corrosion resistant. Croblox<sup>®</sup> gage blocks will maintain their accuracy many times longer than steel blocks. Croblox<sup>®</sup> gage blocks are available in Webber Laboratory Master (LM), and B89 Grades 00 and 0. Webber ceramic gage blocks fit in the gap between steel and croblox<sup>®</sup> and are available in Grades 00 and 0. Ceramic gage blocks are longwearing and corrosion resistant. Ceramic blocks have favorable mechanical and thermal properties that compare the closest to steel of any alternative gage block material. Webber steel gage blocks are only available in B89 Grade 0. Steel is the most economical gage block material available, and steel's thermal and mechanical properties offer the most advantages when used in workshop environments. The disadvantage of steel is its susceptibility to corrosion.

Various styles of gage blocks are available-- rectangular, square, and Webber Heavy Duty. The use of gage blocks can be greatly extended by means of accessories that can be used to build height gages, snap gages, scribers, and dividers.



**Using accessory items, gage blocks can be used to build height gages, snap gages, scribers and dividers. (Webber Heavy Duty style blocks are shown)**

## Angle Blocks



Angle gage blocks furnish fast, very simple and extremely accurate measurements of any angle. They're far superior to sine bar measuring methods, which involve trigonometric formulas and complicated stacks of rectangular gage blocks. A set of Starrett-Webber angle gage blocks consisting of only 16 blocks will measure 356,400 angles in steps of one second, to an accuracy of 1/5,000,000th of a circle!

The reason is because these micro-accurate blocks are designed so that they can be used in either plus or minus positions.

## Angle Blocks (Continued)

For instance, to obtain a measurement of 35° you simply take the 30° angle and add the 5° angle, making sure that both plus ends are together. To get a measurement of 25° you use the same two blocks but bring them together so that the minus end of the 5° block is over the plus end of the 30° block. This will subtract 5° from 30°, thus giving your 25° measurement. Any angle can be quickly and easily obtained in this manner, using only a few blocks in the proper combination of plus and minus positions. Webber angle gage blocks are available in three accuracies:  $\pm 1$  second Reference grade,  $\pm 2$  second Calibration grade, and  $\pm 5$  second Working grade.

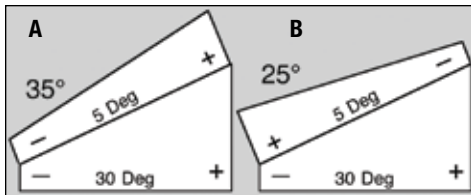

Sketches illustrate how angles of 35° and 25° can be obtained using only two angle gage blocks.

## Optical Flats

Optics are also extensively used in high precision measuring. Starrett-Webber Fused Quartz Optical Flats provide a simple, accurate method for precision measurement of surface flatness by means of the visual interpretation of the light bands that appear when the optical flat is placed on the surface to be checked. Available in accuracies of .000001", .000002" or .000004"; single or double surfaced; coated or uncoated.

1. Single surfaced means one side finished to tolerance. Double surfaced means both sides to tolerance. A side band arrow indicates finished surfaces.
2. Coating purpose is to sharpen the fringe pattern but is of value on single surfaced flats only.

## Optical Polygons

Webber solid chrome carbide Optical Polygons furnish an easy, accurate method of checking and calibrating angles. They are designed for use with autocollimators in measuring angle spacing. The exclusive one-piece design provides compact, fixed masters for checking and calibrating rotary tables.

X-Bar/R Bar.



Fused quartz optical flats provide a quick, extremely accurate means of checking flatness of lapped surfaces.



Optical polygons are used for checking and calibrating angles to extreme accuracy.



## Optical Measuring Projectors

Optical Measuring Projectors (or optical comparators) have been in use by industry for decades. Recent advances in design and technology have further enhanced the capabilities of these two-axis, non-contact gaging systems into highly accurate measuring machines that require a minimum of floor space.

Optical Measuring Projectors are perfect for inspection and comparison of small components which are either lightweight or difficult to fixture, such as flexible gaskets, thin pressings, grinding inspection of mating parts, plastic parts, extrusions, and electronics. Optical projectors provide a wide range of functions such as:

- Comparing drafting specification overlays to a screen projected silhouette.
- Automatic measuring of components which need to meet close tolerances for stringent requirements.
- Inspection of critical mating parts in the finished grinding phase of production.
- The vertical image, large screen size, and workstage travel plus high degrees of accuracy benefit the machine operator by eliminating errors and decreasing inspection time.

**The OV<sup>2</sup>™ Optical Video Adaptor** is a special video camera that can be interchanged with the lens of Starrett Horizontal Optical Measuring Projectors to create a low cost video measuring system.

Now, the OV<sup>2</sup> utilizes the graphic capabilities of QC-300 display, eliminating the need for a separate video output monitor and crosshair generator.

The OV<sup>2</sup> adaptor is available as an option with new Starrett Horizontal Optical Measuring Projectors and as an easy-to-install field retrofit.

- When used with the dual lens Starrett HD400, the OV<sup>2</sup> allows immediate access to both Video and Optical measurement without changing the part setup.



**Starrett Dual Lens HD400-2 Horizontal Axis Benchtop Optical Measuring Projector.**

**The OV<sup>2</sup> Optical-Video Adaptor utilizes the graphic capabilities of the QC300 Display.**



## **Vision Systems** **Galileo CNC Vision Systems**



**Galileo AV612-512"  
System with full CNC  
control and optional  
workstation.**

**Galileo EZ  
Manual System.**



Starrett's Galileo Vision Systems take camera-based measuring systems to the next level. From simple, manual, single-feature operation to complex, automated part measurements, Galileo combines high-resolution images with a sturdy, precision mechanical platform to deliver superb accuracy for a wide range of measuring applications. Starrett Vision Systems are available with a choice of control and software systems and have excellent illumination capabilities. They are constructed to the highest quality standards, providing exceptional performance and consistent, reliable operation. Galileo is easy to use, versatile, accurate, and offers a wide range of options.

**Galileo EZ:** The Galileo EZ is a general-purpose video-based measurement system ideal for quality assurance and inspection labs, and manufacturing, assembly and research facilities. A precision mechanical bearing X-Y-Z stage and column translates data accurately and repeatably to a digital readout, a dedicated metrology display or host PC with measurement software.

## ***Facts About Fits***

In machine construction many of the parts bear such a close and important relation to one another that a certain amount of hand fitting is essential to make the surface contacts as they should be. If the surfaces in contact are to move on each other, the fit is classed as a sliding or running fit. If the surfaces are to make contact with sufficient firmness to hold them together under ordinary use, the fit is classed either as a drive, shrink, or forced fit.

**Sliding Fits:** Under this head may be classed the fitting of cross and traversing slides of lathes, milling machines, drilling machines, boring machines, grinding machines and planers. These fits are usually obtained by scraping or grinding. In most of these fits the moving and stationary parts are held in contact with each other by means of adjustable contact strips or gibs. In some cases, such as the tables of grinding and of planing machines, their weight keeps them in sufficiently close contact.

**Running Fits:** The journal bearings of spindles, crank shafts, line shafting, etc. are classed under this heading.

**Forced Fits and Shrink Fits:** Under this heading are classed those fits where the separate parts must act in use as if they were a single piece: as, for example, a drill bushing in a precision drilling fixture used to precisely locate a hole to be drilled in many identical parts, or the cutter heads and spindles of numerous woodworking machines. A forced fit is obtained by pressing one piece into another. A shrink fit is obtained by heating the outside piece, bringing it into proper relationship with the inside piece and allowing it to shrink into position as it cools.

---

## ***Limits***

In the case of running and of sliding bearings, a certain amount of hand fitting is necessary to obtain desired results, and in all cases certain limiting requirements prevail. In sliding and running bearings the limits are usually those of alignment and of contact, while in either journal bearings or in flat sliding bearings it is essential that certain accurate contact between the surfaces shall be made, and there will also be a limit of alignment with other parts of the machine. For example, in the engine lathe the ways or vees and the cross slide of the tool carriage must be parallel to or at right angles to the axis of the spindle within set limits. In engine lathe construction the limit set for this is 0.001" in a foot length. In testing the parts, use is made of the Universal Test Indicator with the hand reading on a dial. The indicator may be held by a magnetic base indicator holder or clamped to a test bar, a straight edge, or direct to the lathe spindle; also, if desired, it can be and often is held upon a special slider stand fitted to the vees of the machine.

In the making of shrink and force fits, the limits are usually those of size. The amount of pressure necessary to place the two parts together is the limiting factor in the case of force fits. In forcing the axles into diesel locomotive driving wheels, the specifications may limit the force to between one hundred and one hundred fifty tons. However specified, it in fact reduces to limits of size and the use of measuring tools.

## Miscellaneous Measurements

### Measures of Length

1 mile = 1760 yards = 5280 feet

1 yard = 3 feet = 36 inches

1 foot = 12 inches

The following measures of length are also used occasionally:

1 mil = 0.001 inch

1 fathom = 2 yards = 6 feet

1 rod = 5.5 yards = 16.5 feet

1 hand = 4 inches

1 span = 9 inches

### Surveyor's Measure

1 mile = 8 furlongs = 80 chains

1 furlong = 10 chains = 220 yards

1 chain = 4 rods = 22 yards = 66 feet = 100 links

1 link = 7.92 inches

### Square Measure

1 square mile = 640 acres = 6400 square chains

1 acre = 10 square chains = 4840 square yards = 43,560 square feet

1 square chain = 16 square rods = 484 square yards = 4356 square feet

1 square rod = 30.25 square yards = 272.25 square feet = 625 square links

1 square yard = 9 square feet

1 square foot = 144 square inches

An acre is equal to a square, the side of which is 208.7 feet

---

## The Metric System

### Measures of Length

1 Millimeter (mm) = 0.039370079 inch, or about 1/25 inch

10 Millimeters = 1 Centimeter (cm) = 0.39370079 inch

10 Centimeters = 1 Decimeter (d.) = 3.9370079 inch

10 Decimeters = 1 Meter (m) = 39.370079 inches, 3.2808399 feet or 1.09361 yards

10 Meters = 1 Decameter (dam) = 32.808399 feet

10 Decameters = 1 Hectometer (hm) = 19.883878 rods

10 Hectometers = 1 Kilometer (km) = 1093.61 yards or 0.6213712 mile

10 Kilometers = 1 Myriameter (mym) = 6.213712 miles

1 inch = 2.54 cm., 1 foot = 0.3048m., 1 yard = 0.9144m., 1 rod = 0.5029dam

1 mile = 1.6093km.

## Inch to Metric Conversion Table

Decimals to Millimeters				Fractions to Decimals to Millimeters					
Deci- mal	mm	Deci- mal	mm	Frac- tion	Deci- mal	mm	Frac- tion	Deci- mal	mm
0.001	0.0254	0.500	12.7000	1/64	0.0156	0.3969	33/64	0.5156	13.0969
0.002	0.0508	0.510	12.9540	1/32	0.0312	0.7938	17/32	0.5312	13.4938
0.003	0.0762	0.520	13.2080	3/64	0.0469	1.1906	35/64	0.5469	13.8906
0.004	0.1016	0.530	13.4620						
0.005	0.1270	0.540	13.7160						
0.006	0.1524	0.550	13.9700	1/16	0.0625	1.5875	9/16	0.5625	14.2875
0.007	0.1778	0.560	14.2240						
0.008	0.2032	0.570	14.4780						
0.009	0.2286	0.580	14.7320	5/64	0.0781	1.9844	37/64	0.5781	14.6844
		0.590	14.9860	3/32	0.0938	2.3812	19/32	0.5938	15.0812
0.010	0.2540			7/64	0.1094	2.7781	39/64	0.6094	15.4781
0.020	0.5080								
0.030	0.7620								
0.040	1.0160	0.600	15.2400	1/8	0.1250	3.1750	5/8	0.6250	15.8750
0.050	1.2700	0.610	15.4940						
0.060	1.5240	0.620	15.7480						
0.070	1.7780	0.630	16.0020	9/64	0.1406	3.5719	41/64	0.6406	16.2719
0.080	2.0320	0.640	16.2560	5/32	0.1562	3.9688	21/32	0.6562	16.6688
0.090	2.2860	0.650	16.5100	11/64	0.1719	4.3656	43/64	0.6719	17.0656
		0.660	16.7640						
0.100	2.5400	0.670	17.0180						
0.110	2.7940	0.680	17.2720	3/16	0.1875	4.7625	11/16	0.6875	17.4625
0.120	3.0480	0.690	17.5260						
0.130	3.3020								
0.140	3.5560			13/64	0.2031	5.1594	45/64	0.7031	17.8594
0.150	3.8100			7/32	0.2188	5.5562	23/32	0.7188	18.2562
0.160	4.0640	0.700	17.7800	15/64	0.2344	5.9531	47/64	0.7344	18.6531
0.170	4.3180	0.710	18.0340						
0.180	4.5720	0.720	18.2880						
0.190	4.8260	0.730	18.5420	1/4	0.2500	6.3500	3/4	0.7500	19.0500
		0.740	18.7960						
0.200	5.0800	0.750	19.0500						
0.210	5.3340	0.760	19.3040	17/64	0.2656	6.7469	49/64	0.7656	19.4469
0.220	5.5880	0.770	19.5580	9/32	0.2812	7.1438	25/32	0.7812	19.8438
0.230	5.8420	0.780	19.8120	19/64	0.2969	7.5406	51/64	0.7969	20.2406
0.240	6.0960	0.790	20.0660						
0.250	6.3500								
0.260	6.6040			5/16	0.3125	7.9375	13/16	0.8125	20.6375
0.270	6.8580								
0.280	7.1120	0.800	20.3200						
0.290	7.3660	0.810	20.5740	21/64	0.3281	8.3344	53/64	0.8281	21.0344
		0.820	20.8280	11/32	0.3438	8.7312	27/32	0.8438	21.4312
0.300	7.6200	0.830	21.0820	23/64	0.3594	9.1281	55/64	0.8594	21.8281
0.310	7.8740	0.840	21.3360						
0.320	8.1280	0.850	21.5900						
0.330	8.3820	0.860	21.8440	3/8	0.3750	9.5250	7/8	0.8750	22.2250
0.340	8.6360	0.870	22.0980						
0.350	8.8900	0.880	22.3520						
0.360	9.1440	0.890	22.6060	25/64	0.3906	9.9219	57/64	0.8906	22.6219
0.370	9.3980			13/32	0.4062	10.3188	29/32	0.9062	23.0188
0.380	9.6520			27/64	0.4219	10.7156	59/64	0.9219	23.4156
0.390	9.9060								
		0.900	22.8600						
0.400	10.1600	0.910	23.1140	7/16	0.4375	11.1125	15/16	0.9375	23.8125
0.410	10.4140	0.920	23.3680						
0.420	10.6680	0.930	23.6220						
0.430	10.9220	0.940	23.8760	29/64	0.4531	11.5094	61/64	0.9531	24.2094
0.440	11.1760	0.950	24.1300	15/32	0.4688	11.9062	31/32	0.9688	24.6062
0.450	11.4300	0.960	24.3840	31/64	0.4844	12.3031	63/64	0.9844	25.0031
0.460	11.6840	0.970	24.6380						
0.470	11.9380	0.980	24.8920						
0.480	12.1920	0.990	25.1460	1/2	0.5000	12.7000	1	1.0000	25.4000
0.490	12.4460	1.000	25.4000						

## Decimal Equivalents, Squares, Cubes, Square and Cube Roots, Circumferences and Areas of Circles, From 1/64" to 5/8"

Frac-tion	Dec. Equiv.	Square	Sq. Root	Cube	Cube Root	Circle*	
						Circum.	Area
1/64	.015625	.0002441	.125	.000003815	.25	.04909	.000192
1/32	.03125	.0009766	.176777	.000030518	.31498	.09817	.000767
3/64	.046875	.0021973	.216506	.000102997	.36056	.14726	.001726
1/16	.0625	.0039063	.25	.00024414	.39685	.19635	.003068
5/64	.078125	.0061035	.279508	.00047684	.42749	.24544	.004794
3/32	.09375	.0087891	.306186	.00082397	.45428	.29452	.006903
7/64	.109375	.0119629	.330719	.0013084	.47823	.34361	.009396
1/8	.125	.015625	.353553	.0019531	.5	.39270	.012272
9/64	.140625	.0197754	.375	.0027809	.52002	.44179	.015532
5/32	.15625	.0244141	.395285	.0038147	.53861	.49087	.019175
11/64	.171875	.0295410	.414578	.0050774	.55600	.53996	.023201
3/16	.1875	.0351563	.433013	.0065918	.57236	.58905	.027611
13/64	.203125	.0412598	.450694	.0083809	.58783	.63814	.032405
7/32	.21875	.0478516	.467707	.010468	.60254	.68722	.037583
15/64	.234375	.0549316	.484123	.012875	.61655	.73631	.043143
1/4	.25	.0625	.5	.015625	.62996	.78540	.049087
17/64	.265625	.0705566	.515388	.018742	.64282	.83449	.055415
9/32	.28125	.0791016	.530330	.022247	.65519	.88357	.062126
19/64	.296875	.0881348	.544862	.026165	.66710	.93266	.069221
5/16	.3125	.0976562	.559017	.030518	.67860	.98175	.076699
21/64	.328125	.107666	.572822	.035328	.68973	1.03084	.084561
11/32	.34375	.118164	.586302	.040619	.70051	1.07992	.092806
23/64	.359375	.129150	.599479	.046413	.71097	1.12901	.101434
3/8	.375	.140625	.612372	.052734	.72112	1.17810	.110445
25/64	.390625	.1525879	.625	.059605	.73100	1.22718	.119842
13/32	.40625	.1650391	.637377	.067047	.74062	1.27627	.129621
27/64	.421875	.1779785	.649519	.075085	.75	1.32536	.139784
7/16	.4375	.1914063	.661438	.083740	.75915	1.37445	.150330
29/64	.453125	.2053223	.673146	.093037	.76808	1.42353	.161260
15/32	.46875	.2197266	.684653	.102997	.77681	1.47262	.172573
31/64	.484375	.2346191	.695971	.113644	.78535	1.52171	.184269
1/2	.5	.25	.707107	.125	.79370	1.57080	.196350
33/64	.515625	.265869	.718070	.137089	.80188	1.61988	.208813
17/32	.53125	.282227	.728869	.149933	.80990	1.66897	.221660
35/64	.546875	.299072	.739510	.163555	.81777	1.71806	.234891
9/16	.5625	.316406	.75	.177979	.82548	1.76715	.248505
37/64	.578125	.334229	.760345	.193226	.83306	1.81623	.262502
19/32	.59375	.352539	.770552	.209320	.84049	1.86532	.276884
39/64	.609375	.371338	.780625	.226284	.84780	1.91441	.291648
5/8	.625	.390625	.790569	.244141	.85499	1.96350	.306796

\* Fraction represents diameter.

continued on next page

## Decimal Equivalents, Squares, Cubes, Square & Cube Roots, Circumferences & Areas of Circles, From 41/64" to 1"

Frac-tion	Dec. Equiv.	Square	Sq. Root	Cube	Cube Root	Circle*	
						Circum.	Area
41/64	.640625	.410400	.800391	.262913	.86205	2.01258	.322328
21/32	.65625	.430664	.810093	.282623	.86901	2.06167	.338243
43/64	.671875	.451416	.819680	.303295	.87585	2.11076	.354541
11/16	.6875	.472656	.829156	.324951	.88259	2.15984	.371223
45/64	.703125	.494385	.838525	.347614	.88922	2.20893	.388289
23/32	.71875	.516602	.847791	.371307	.89576	2.25802	.405737
47/64	.734375	.539307	.856957	.396053	.90221	2.30711	.423570
3/4	.75	.5625	.866025	.421875	.90856	2.35619	.441786
49/64	.765625	.586182	.875	.448795	.91483	2.40528	.460386
25/32	.78125	.610352	.883883	.476837	.92101	2.45437	.479369
51/64	.796875	.635010	.892679	.506023	.92711	2.50346	.498736
13/16	.8125	.660156	.901388	.536377	.93313	2.55254	.518486
53/64	.828125	.685791	.910014	.567921	.93907	2.60163	.538619
27/32	.84375	.711914	.918559	.600677	.94494	2.65072	.559136
55/64	.859375	.738525	.927024	.634670	.95074	2.69981	.580036
7/8	.875	.765625	.935414	.669922	.95647	2.74889	.601320
57/64	.890625	.793213	.943729	.706455	.96213	2.79798	.622988
29/32	.90625	.821289	.951972	.744293	.96772	2.84707	.645039
59/64	.921875	.849854	.960143	.783459	.97325	2.89616	.667473
15/16	.9375	.878906	.968246	.823975	.97872	2.94524	.690291
61/64	.953125	.908447	.976281	.865864	.98412	2.99433	.713493
31/32	.96875	.938477	.984251	.909149	.98947	3.04342	.737078
63/64	.984375	.968994	.992157	.953854	.99476	3.09251	.761046
1	1	1	1	1	1	3.14159	.785398

\* Fraction represents diameter.

## Screw Threads & Tap Drill Sizes

N C or A. S. M. E. SPECIAL MACHINE SCREWS			
Size of Tap	Thds. per Inch	Tap Drill	Body Drill
1	64	53	48
2	56	50	44
3	48	47	39
4	40	43	33
5	40	38	1/8
6	32	36	28
8	32	29	19
10	24	25	11
12	24	16	7/32

N F or A. S. M. E. SPECIAL MACHINE SCREWS			
Size of Tap	Thds. per Inch	Tap Drill	Body Drill
2	64	50	44
3	56	45	39
4	48	42	33
5	44	37	1/8
6	40	33	28
8	36	29	19
10	32	21	11
*10	30	22	11
12	28	14	7/32

\* A. S. M. E. Only

AMERICAN STANDARD TAPER PIPE THREADS			
Size of Tap	Thds. per Inch	Tap Drill	Body Drill
1/8	27	11/32	
1/4	18	7/16	
3/8	18	37/64	
1/2	14	23/32	
3/4	14	59/64	
1	11-1/2	1-5/32	
1-1/4	11-1/2	1-1/2	
1-1/2	11-1/2	1-3/4	
2	11-1/2	2-7/32	
2-1/2	8	2-21/32	
3	8	3-1/4	
3-1/2	8	3-3/4	
4	8	4-1/4	

N F or S.A.E. STANDARD SCREWS			
Size of Tap	Thds. per Inch	Tap Drill	Body Drill
1/4	28	3	3
5/16	24	4	1
3/8	24	0	0
7/16	20	25/64	25/64
1/2	20	29/64	29/64
9/16	18	33/64	33/64
5/8	18	37/64	37/64
11/16	16	5/8	5/8
3/4	16	11/16	11/16
7/8	14	13/16	13/16
1	14	15/16	15/16
1-1/8	12	1-3/64	1-3/64

Tap Drills allow approx. 75% Full Thread



## Number & Letter Sizes of Drills With Decimal Equivalents

Sizes starting with No. 80 and going up to 1 inch. This table is useful for quickly determining the nearest drill size for any decimal, for root diameters, body drills, etc.

Drill No.	Frac.	Deci.	Drill No.	Frac.	Deci.	Drill No.	Frac.	Deci.	Drill No.	Frac.	Deci.
80	—	.0135	42	—	.0935	7	—	.2010	X	—	.3970
79	—	.0145	—	3/32	.0938	—	13/64	.2031	Y	—	.4040
—	1/64	.0156	—	—	—	6	—	.2040	—	—	—
78	—	.0160	41	—	.0960	5	—	.2055	—	13/32	.4062
77	—	.0180	40	—	.0980	4	—	.2090	Z	—	.4130
—	—	—	39	—	.0995	—	—	—	—	27/64	.4219
76	—	.0200	38	—	.1015	3	—	.2130	—	7/16	.4375
75	—	.0210	37	—	.1040	—	7/32	.2188	—	29/64	.4531
74	—	.0225	—	—	—	2	—	.2210	—	—	—
73	—	.0240	36	—	.1065	1	—	.2280	—	15/32	.4688
72	—	.0250	—	7/64	.1094	A	—	.2340	—	31/64	.4844
—	—	—	35	—	.1100	—	—	—	—	1/2	.5000
71	—	.0260	34	—	.1110	—	15/64	.2344	—	33/64	.5156
70	—	.0280	33	—	.1130	B	—	.2380	—	17/32	.5312
69	—	.0292	—	—	—	C	—	.2420	—	—	—
68	—	.0310	32	—	.1160	D	—	.2460	—	35/64	.5469
—	1/32	.0312	31	—	.1200	—	1/4	.2500	—	9/16	.5625
—	—	—	—	1/8	.1250	—	—	—	—	37/64	.5781
67	—	.0320	30	—	.1285	E	—	.2500	—	19/32	.5938
66	—	.0330	29	—	.1360	F	—	.2570	—	39/64	.6094
65	—	.0350	—	—	—	G	—	.2610	—	—	—
64	—	.0360	28	—	.1405	—	17/64	.2656	—	5/8	.6250
63	—	.0370	—	9/64	.1406	H	—	.2660	—	41/64	.6406
—	—	—	27	—	.1440	—	—	—	—	21/32	.6562
62	—	.0380	26	—	.1470	I	—	.2720	—	43/64	.6719
61	—	.0390	25	—	.1495	J	—	.2770	—	11/16	.6875
60	—	.0400	—	—	—	—	9/32	.2812	—	—	—
59	—	.0410	24	—	.1520	K	—	.2810	—	45/64	.7031
58	—	.0420	23	—	.1540	L	—	.2900	—	23/32	.7188
—	—	—	—	5/32	.1562	—	—	—	—	47/64	.7344
57	—	.0430	22	—	.1570	M	—	.2950	—	3/4	.7500
56	—	.0465	21	—	.1590	—	19/64	.2969	—	49/64	.7656
—	3/64	.0469	—	—	—	N	—	.3020	—	—	—
55	—	.0520	—	—	—	—	5/16	.3125	—	25/32	.7812
54	—	.0550	20	—	.1610	O	—	.3160	—	51/64	.7969
—	—	—	19	—	.1660	—	—	—	—	13/16	.8125
53	—	.0595	18	—	.1695	P	—	.3230	—	53/64	.8281
—	1/16	.0625	—	11/64	.1719	—	21/64	.3281	—	27/32	.8438
52	—	.0635	17	—	.1730	Q	—	.3320	—	—	—
51	—	.0670	—	—	—	R	—	.3390	—	—	—
50	—	.0700	16	—	.1770	—	11/32	.3438	—	55/64	.8594
—	—	—	15	—	.1800	—	—	—	—	7/8	.8750
49	—	.0730	14	—	.1820	S	—	.3480	—	57/64	.8906
48	—	.0760	13	—	.1850	T	—	.3580	—	29/32	.9062
—	5/64	.0781	—	3/16	.1875	—	23/64	.3594	—	59/64	.9219
47	—	.0785	—	—	—	U	—	.3680	—	—	—
46	—	.0810	12	—	.1890	—	3/8	.3750	—	15/16	.9375
—	—	—	11	—	.1910	—	—	—	—	61/64	.9531
45	—	.0820	10	—	.1935	V	—	.3770	—	31/32	.9688
44	—	.0860	9	—	.1960	W	—	.3860	—	63/64	.9844
43	—	.0890	8	—	.1990	—	25/64	.3906	—	1	1.0000



## Suggested Cutting Speeds & Feeds for Drills

The following information is a good general guide. Specific jobs may have to be modified because of varying conditions on the job, such as coolant, equipment and job requirements.

Drill feeds are governed by the size of the drill and also the material to be drilled: a feed of .001 to .002" per revolution for drills smaller than 1/8", .002 to .004" for drills 1/8 to 1/4", .004 to .007" for drills 1/4 to 1/2", .007 to .015" for drills 1/2 to 1" and .015 to .025" for drills larger than 1" are recommended. The lower feeds should be used when drilling relatively hard materials such as alloy steels and the higher feeds should be used when drilling relatively soft materials such as aluminum and brass.

These feeds are based on the peripheral speed of a drill. Recommended approximate peripheral speeds for carbon steel twist drills are as follows: 30 feet per minute for machinery steel; 35 feet per minute for cast iron; 60 feet per minute for brass. Recommended approximate peripheral speeds for high speed steel drills are: 80 feet per minute for machinery steel; 100 feet per minute for cast iron; 50 feet per minute for alloy steel and 200 feet per minute for brass.

Drill Diam., Inches	FEET PER MINUTE										
	30	40	50	60	70	80	90	100	150	200	250
	REVOLUTIONS PER MINUTE										
1/16	1833	2445	3056	3667	4278	4889	5500	6112	9167	12223	15279
1/8	917	1222	1528	1833	2139	2445	2750	3056	4584	6112	7639
3/16	611	815	1019	1222	1426	1630	1833	2037	3056	4074	5093
1/4	458	611	764	927	1070	1222	1375	1528	2292	3056	3820
5/16	367	489	611	733	856	978	1100	1222	1833	2445	3056
3/8	306	407	509	611	713	815	917	1019	1528	2037	2546
7/16	262	349	437	524	611	698	786	873	1310	1746	2183
1/2	229	306	382	458	535	611	688	764	1146	1528	1910
5/8	183	244	306	367	428	489	550	611	917	1222	1528
3/4	153	204	255	306	357	407	458	509	764	1019	1273
7/8	131	175	218	262	306	349	393	473	655	873	1091
1	115	153	191	229	267	306	344	382	573	764	955
1-1/8	102	136	170	204	238	272	306	340	509	679	849
1-1/4	92	122	153	183	214	244	275	306	458	611	764
1-3/8	83	111	139	167	194	222	250	278	417	556	694
1-1/2	76	102	127	153	178	204	229	255	382	509	637
1-5/8	71	94	118	141	165	188	212	235	353	470	588
1-3/4	66	87	109	131	153	175	196	218	327	437	546
1-7/8	61	82	102	122	143	163	183	204	306	407	509
2	57	76	96	115	134	153	172	191	287	382	477
2-1/4	51	68	85	102	119	136	153	170	255	340	424
2-1/2	46	61	76	92	107	122	138	153	229	306	382
2-3/4	42	56	70	83	97	111	125	139	208	278	347
3	38	51	64	76	89	102	115	127	191	255	318
3-1/4	35	47	59	71	82	94	106	118	176	235	294
3-1/2	33	44	55	66	76	87	98	109	164	218	273
3-3/4	31	41	51	61	71	81	92	102	153	204	255
4	29	38	48	57	67	76	86	96	143	191	239
4-1/2	26	34	42	51	59	68	76	85	127	170	212
5	23	31	38	46	54	61	69	76	115	153	191
5-1/2	21	28	35	42	49	56	63	70	104	139	174
6	19	26	32	38	45	51	57	64	96	127	159
6-1/2	18	24	29	35	41	47	53	59	88	118	147
7	16	22	27	33	38	44	49	55	82	109	136
7-1/2	15	20	26	31	36	41	46	51	76	102	127
8	14	19	24	29	33	38	43	48	72	96	119

## Double Depth of Threads

Threads per In. N	V Threads D D	Am. Nat. Form DD U. S. Std.	Whitworth Standard D D	Threads per In. N	V Threads D D	Am. Nat. Form DD U. S. Std.	Whitworth Standard D D
2	.86650	.64950	.64000	28	.06185	.04639	.04571
2-1/4	.77022	.57733	.56888	30	.05773	.04330	.04266
2-3/8	.72960	.45694	.53894	32	.05412	.04059	.04000
2-1/2	.69320	.51960	.51200	34	.05097	.03820	.03764
2-5/8	.66015	.49485	.48761	36	.04811	.03608	.03555
2-3/4	.63019	.47236	.45545	38	.04560	.03418	.03368
2-7/8	.60278	.45182	.44521	40	.04330	.03247	.03200
3	.57733	.43300	.42666	42	.04126	.03093	.03047
3-1/4	.53323	.39966	.39384	44	.03936	.02952	.02909
3-1/2	.49485	.37114	.35571	46	.03767	.02823	.02782
4	.43300	.32475	.32000	48	.03608	.02706	.02666
4-1/2	.38438	.28869	.23444	50	.03464	.02598	.02560
5	.34660	.25980	.25600	52	.03332	.02498	.02461
5-1/2	.31490	.23618	.23272	54	.03209	.02405	.02370
6	.28866	.21650	.21333	56	.03093	.02319	.02285
7	.24742	.18557	.13285	58	.02987	.02239	.02206
8	.21650	.16237	.15000	60	.02887	.02165	.02133
9	.19244	.14433	.14222	62	.02795	.02095	.02064
10	.17320	.12990	.12800	64	.02706	.02029	.02000
11	.15745	.11809	.11636	66	.02625	.01968	.01939
11-1/2	.15069	.11295	.11121	68	.02548	.01910	.01882
12	.14433	.10825	.10666	70	.02475	.01855	.01728
13	.13323	.09992	.09846	72	.02407	.01804	.01782
14	.12357	.09278	.09142	74	.02341	.01752	.01729
15	.11555	.08660	.08533	76	.02280	.01714	.01673
16	.10825	.08118	.08000	78	.02221	.01665	.01641
18	.09622	.07216	.07111	80	.02166	.01623	.01600
20	.08660	.06495	.06400	82	.02113	.01584	.01560
22	.07872	.05904	.05818	84	.02063	.01546	.01523
24	.07216	.05412	.05333	86	.02015	.01510	.01476
26	.06661	.04996	.04923	88	.01957	.01476	.01454
27	.06418	.04811	.04740	90	.01925	.01443	.01422

$$D D = \frac{1.733}{N} \text{ For V Thread}$$

$$D D = \frac{1.299}{N} \text{ For American Nat. Form, U. S. Std.}$$

$$D D = \frac{1.28}{N} \text{ For Whitworth Standard}$$

## Tapers & Angles

Taper per Foot	Included Angle			Angle With Center Line			Taper per Inch	Taper per Inch from Center Line
	Deg.	Min.	Sec.	Deg.	Min.	Sec.		
1/8	0	35	49	0	17	54	.010417	.005208
3/16	0	53	43	0	26	51	.015625	.007813
1/4	1	11	37	0	35	49	.020833	.010417
5/16	1	29	31	0	44	46	.026042	.013021
3/8	1	47	25	0	53	43	.031250	.015625
7/16	2	5	19	1	2	40	.036458	.018229
1/2	2	23	13	1	11	37	.041667	.020833
9/16	2	41	7	1	20	33	.046875	.023438
5/8	2	59	1	1	29	30	.052083	.026042
11/16	3	16	54	1	38	27	.057292	.028646
3/4	3	34	47	1	47	24	.062500	.031250
13/16	3	52	41	1	56	20	.067708	.033854
7/8	4	10	33	2	5	17	.072917	.036458
15/16	4	28	26	2	14	13	.078125	.039063
1	4	46	19	2	23	9	.083333	.041667
1-1/4	5	57	47	2	58	53	.104167	.052084
1-1/2	7	9	10	3	34	35	.125000	.062500
1-3/4	8	20	27	4	10	14	.145833	.072917
2	9	31	38	4	45	49	.166667	.083333
2-1/2	11	53	37	5	56	49	.208333	.104167
3	14	15	0	7	7	30	.250000	.125000
3-1/2	16	35	39	8	17	50	.291667	.145833
4	18	55	29	9	27	44	.333333	.166667
4-1/2	21	14	22	10	37	11	.375000	.187500
5	23	32	12	11	46	6	.416667	.208333
6	28	4	21	14	2	10	.500000	.250000

## Triangle Chart

For the Rapid Solution of Right-Angle and Oblique-Angle Triangles

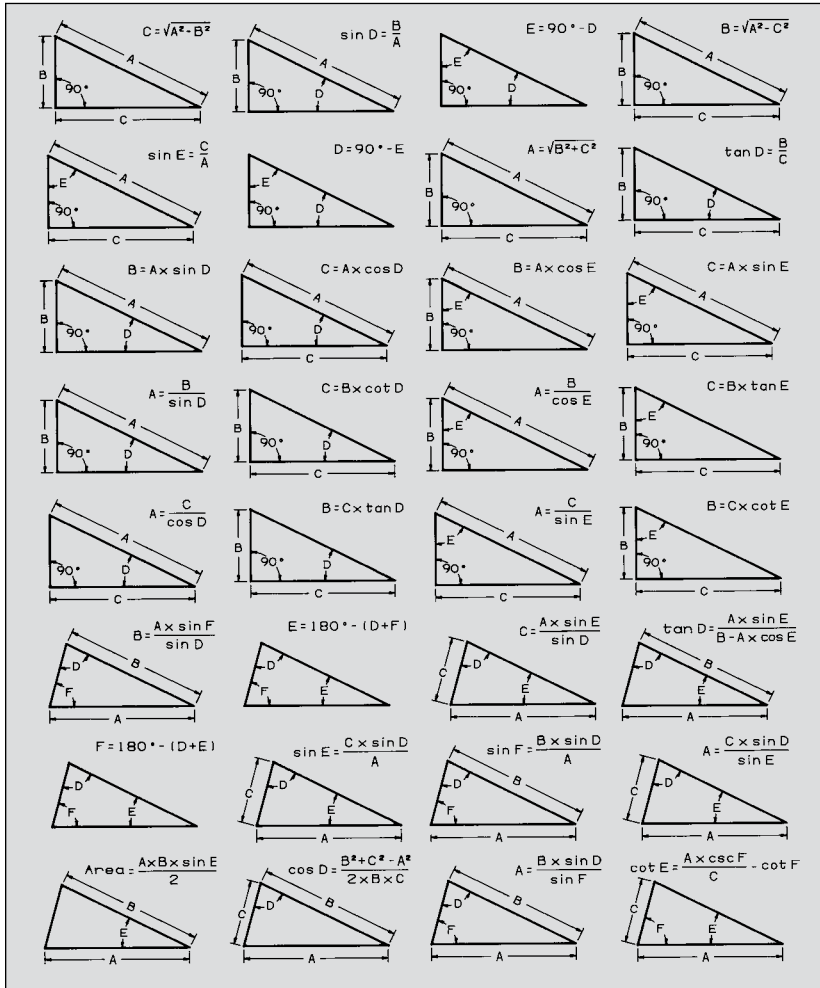

## IP Ratings

### First Digit

The first digit indicates the level of protection that the enclosure provides against access to hazardous parts (e.g., electrical conductors, moving parts) and the ingress of solid foreign objects.

Level	Protected Against	Effective Against
0	—	No protection against contact and ingress of objects.
1	Objects >50mm	Any large surface of the body, such as the back of a hand, but no protection against deliberate contact with a body part.
2	Objects >12.5mm	Fingers or similar objects.
3	Objects >2.5mm	Tools, thick wires, etc.
4	Objects >1mm	Most wires, screws, etc.
5	Dust protected	Ingress of dust is not entirely prevented, but it must not enter in sufficient quantity to interfere with the satisfactory operation of the equipment; complete protection against contact.
6	Dust tight	No ingress of dust; complete protection against contact.

### Second Digit

Protection of the equipment inside the enclosure against harmful ingress of water.

Level	Protected Against	Details
0	Not protected	—
1	Dripping water	Dripping water (vertically falling drops) shall have no harmful effect.
2	Dripping water when tilted up to 15°	Vertically dripping water shall have no harmful effect when the enclosure is tilted at an angle up to 15° from its normal position.
3	Spraying water	Water falling as a spray at any angle up to 60° from the vertical shall have no harmful effect.
4	Splashing water	Water splashing against the enclosure from any direction shall have no harmful effect.
5	Water jets	Water projected by a nozzle against enclosure from any direction shall have no harmful effects.
6	Powerful water jets	Water projected in powerful jets against the enclosure from any direction shall have no harmful effects.
7	Immersion up to 1m	Ingress of water in harmful quantity shall not be possible when the enclosure is immersed in water under defined conditions of pressure and time (up to 1m of submersion).
8	Immersion beyond 1m	The equipment is suitable for continuous immersion in water under conditions which shall be specified by the manufacturer. <b>NOTE:</b> Normally, this will mean that the equipment is hermetically sealed. However, with certain types of equipment, it can mean that water can enter but only in such a manner that produces no harmful effects.

## ***Educational Material***

### ***Other Training Aids Available:***

- **The Starrett Story** – Bulletin No 1216 (FREE in reasonable quantities)
- **\*The Starrett Book for Student Machinists** – Catalog No. 1700 (EDP No. 53218)
- **Decimal Wall Chart**
- **\*Educational Charts** – Sets of Seventeen (Available in 2 sizes)
  - Wall size is 18-5/8" x 14-5/8" – Catalog No. 1702 (EDP No. 56172)
  - Three-ring notebook size – 11" x 8-1/2" Catalog No. 1715 (EDP No. 53220)
- **Pocket Size Cards** – (FREE in reasonable quantities)
  - Inch/Metric Tap Drill Sizes and Decimal Equivalents
  - Millimeter/Inch Equivalents
- **\*Training Aid Kit** – Catalog No. 1701 (EDP No. 53219) Set of 4 tool slide charts:
  - Outside Micrometer
  - Vernier Caliper
  - Vernier Height Gage
  - Vernier Protractor

Please order no cost materials by selecting the "Literature" button on the Starrett website (starrett.com). From there, you can select these materials through a "Shopping Cart" interface.

**\*NOTE:** Priced item. Refer to current price list.



# Tools & Rules for Precision Measuring

*“I have believed that I could do no greater good than help create a business that would give people employment and a chance to earn an honest living.”*

*Laroy S. Starrett (1836-1922) Founder of  
The L. S. Starrett Company*



[starrett.com](http://starrett.com)